

# User Manual

**Tektronix**

---

## **TDS3TRG Advanced Trigger Application Module**

Also includes TDS3FFT, TDS3VID,  
& TDS3TMT manuals

**071-0305-01**

**McGrath - RenTelco**

**Your Test Equipment &  
Communications Rental Specialists  
800-352-2900**

**Return Equipment To:**  
5700 Las Positas Road  
Livermore, CA 94550  
[www.mcgrath-rentelco.com](http://www.mcgrath-rentelco.com)



071030501

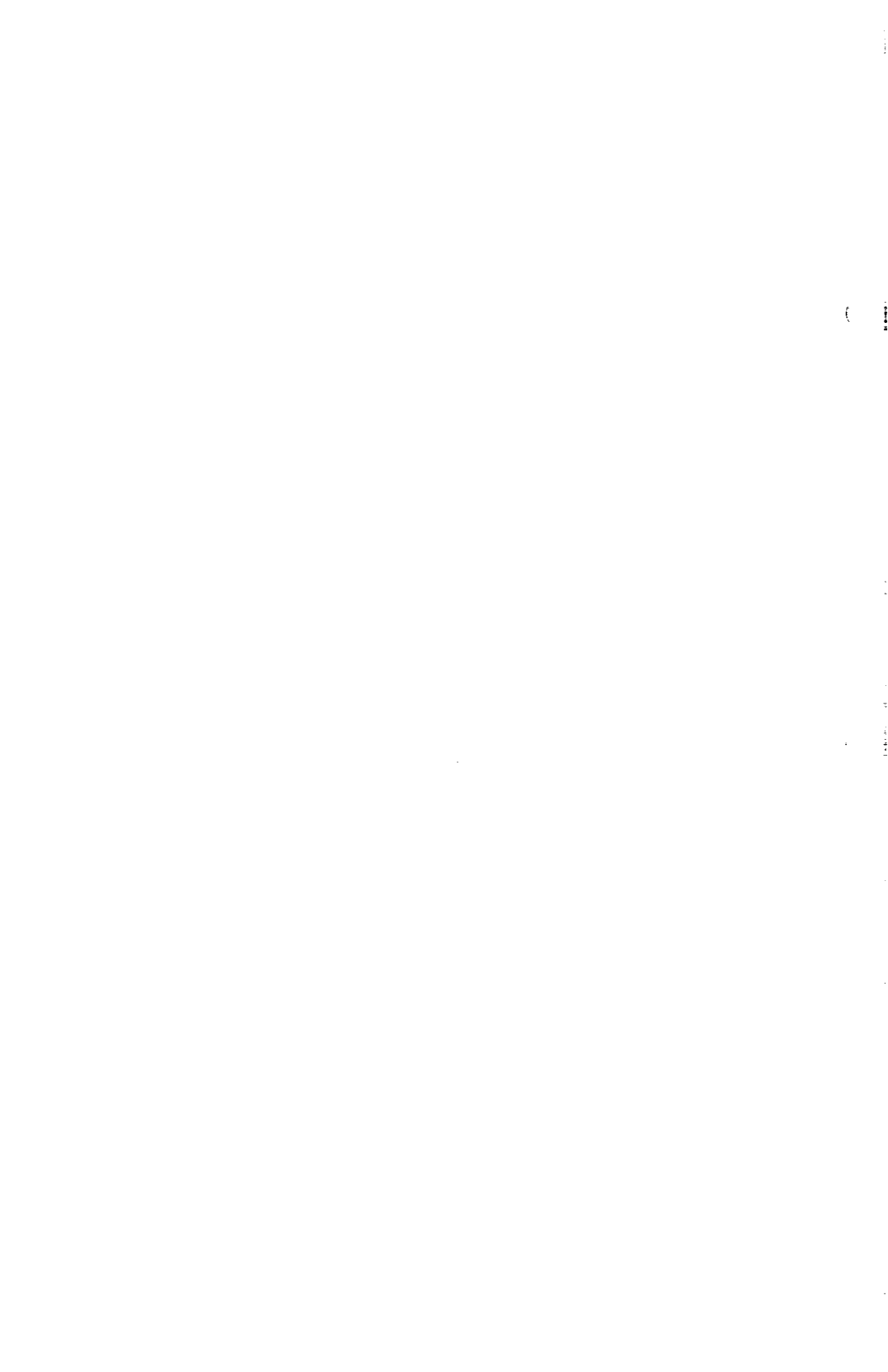

# **User Manual**



## **TDS3TRG Advanced Trigger Application Module**

**071-0305-01**

This document supports firmware version 2.00  
and above.

Copyright © Tektronix, Inc. All rights reserved.

Tektronix products are covered by U.S. and foreign patents, issued and pending. Information in this publication supercedes that in all previously published material. Specifications and price change privileges reserved.

Printed in the U.S.A.

Tektronix, Inc., P.O. Box 1000, Wilsonville, OR 97070-1000

TEKTRONIX and TEK are registered trademarks of Tektronix, Inc.

DPX is a trademark of Tektronix, Inc.

## **WARRANTY SUMMARY**

Tektronix warrants that the products that it manufactures and sells will be free from defects in materials and workmanship for a period of three (3) years from the date of shipment from an authorized Tektronix distributor. If a product proves defective within the respective period, Tektronix will provide repair or replacement as described in the complete warranty statement.

To arrange for service or obtain a copy of the complete warranty statement, please contact your nearest Tektronix sales and service office.

**EXCEPT AS PROVIDED IN THIS SUMMARY OR THE APPLICABLE WARRANTY STATEMENT, TEKTRONIX MAKES NO WARRANTY OF ANY KIND, EXPRESS OR IMPLIED, INCLUDING WITHOUT LIMITATION THE IMPLIED WARRANTIES OF MERCHANTABILITY AND FITNESS FOR A PARTICULAR PURPOSE. IN NO EVENT SHALL TEKTRONIX BE LIABLE FOR INDIRECT, SPECIAL OR CONSEQUENTIAL DAMAGES.**





# Table of Contents

<b>General Safety Summary</b> .....	<b>iii</b>
<b>Preface</b> .....	<b>v</b>
Contacting Tektronix .....	vi

## Getting Started

Installing Application Module and Firmware .....	1
Checking Module Installation .....	4
Troubleshooting Module Installation .....	5

## Operating Basics

Advanced Trigger Features .....	6
Accessing Advanced Triggering .....	8
Advanced Trigger Concepts .....	9

## Reference

Conventions .....	15
Pattern Triggering .....	16
State Triggering .....	21
Pulse Width Triggering .....	25
Runt Pulse Triggering .....	29
Slew Rate Triggering .....	33

## Appendix

Appendix A: Specifications .....	38
----------------------------------	----

## Table of Contents

---



# General Safety Summary

Review the following safety precautions to avoid injury and prevent damage to this product or any products connected to it. To avoid potential hazards, use this product only as specified.

*Only qualified personnel should perform service procedures.*

While using this product, you may need to access other parts of the system. Read the *General Safety Summary* in other system manuals for warnings and cautions related to operating the system.

## To Avoid Fire or Personal Injury

**Do Not Operate With Suspected Failures.** If you suspect there is damage to this product, have it inspected by qualified service personnel.

**Do Not Operate in Wet/Damp Conditions.**

**Do Not Operate in an Explosive Atmosphere.**

## Safety Terms and Symbols

**Terms in This Manual.** The following term appears in this manual:



---

**CAUTION.** *Caution statements identify conditions or practices that could result in damage to this product or other property.*

---

## Preventing Electrostatic Damage



---

**CAUTION.** *Electrostatic discharge (ESD) can damage components in the oscilloscope and its accessories. To prevent ESD, observe these precautions when directed to do so.*

---

**Use a Ground Strap.** Wear a grounded antistatic wrist strap to discharge the static voltage from your body while installing or removing sensitive components.

**Use a Safe Work Area.** Do not use any devices capable of generating or holding a static charge in the work area where you install or remove sensitive components. Avoid handling sensitive components in areas that have a floor or benchtop surface capable of generating a static charge.

**Handle Components Carefully.** Do not slide sensitive components over any surface. Do not touch exposed connector pins. Handle sensitive components as little as possible.

**Transport and Store Carefully.** Transport and store sensitive components in a static-protected bag or container.



# Preface

This User Manual describes the capabilities, operation, and applications of the TDS3TRG Advanced Trigger application module. The following table shows you where to find information in this manual.

<b>If you are looking for:</b>	<b>Turn to:</b>
Installation information	<i>Installing Application Module and Firmware</i> on page 1
Product overview	<i>Advanced Trigger Features</i> on page 6
Basic operating instructions	<i>Accessing Advanced Triggering</i> on page 8
Understanding advanced triggering	<i>Advanced Trigger Concepts</i> on page 9
Function details	<i>Reference</i> section starting on page 15
Technical specifications	<i>Specifications</i> appendix on page 38

## Contacting Tektronix

Product Support	<p>For questions about using Tektronix measurement products, call toll free in North America: 1-800-TEK-WIDE (1-800-835-9433 ext. 2400) 6:00 a.m. – 5:00 p.m. Pacific time</p> <p>Or contact us by e-mail: tm_app_supp@tektronix.com</p> <p>For product support outside of North America, contact your local Tektronix distributor or sales office.</p>
Service Support	<p>Tektronix offers extended warranty and calibration programs as options on many products. Contact your local Tektronix distributor or sales office.</p> <p>For a listing of worldwide service centers, visit our web site.</p>
For other information	<p>In North America: 1-800-TEK-WIDE (1-800-835-9433) An operator will direct your call.</p>
To write us	<p>Tektronix, Inc. P.O. Box 1000 Wilsonville, OR 97070-1000 USA</p>
Website	<p>Tektronix.com</p>

# Getting Started

This chapter describes how to install and check the TDS3TRG Advanced Trigger application module.

## Installing Application Module and Firmware

You can install up to four application modules in the oscilloscope. Application modules go into the two slots with windows in the upper right corner of the front panel. Two additional slots are located behind the two front slots.

---

**NOTE.** *You do not need to do the following procedure if you purchased a four-channel oscilloscope with pre-installed application modules.*

*You must do the firmware install procedure the first time you install a new application module.*

*You do not need to reinstall the firmware if you remove and reinstall an application module.*

---



---

**CAUTION.** *To avoid damage to the oscilloscope or application module, observe the ESD precautions described on page iv.*

---

To install an application module and its associated oscilloscope firmware, do these steps:

1. Save any oscilloscope settings and/or reference waveforms to floppy disk before doing these steps.
2. Turn the oscilloscope power off.
3. Open the small door in the upper right corner of the front panel.
4. Slide the application module into any available slot with the module contacts facing the circuit board. Use a small screwdriver to remove an existing module if it is necessary to make space for a new application module.
5. Close the module door.

---

**NOTE.** *If you remove an application module, the features provided by that application module are no longer available. You can reinstall the module to restore the features.*

---

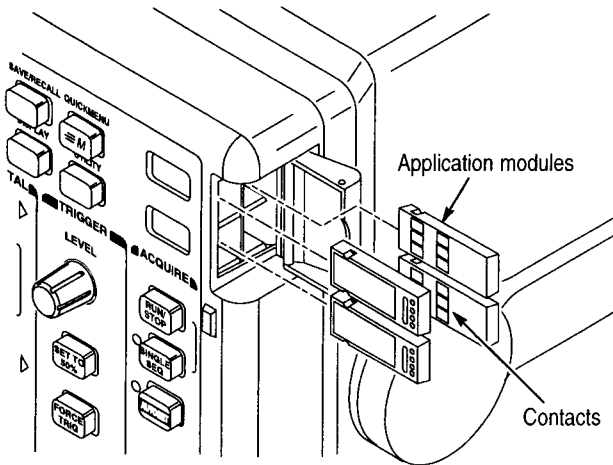

6. If the application module came with one or more floppy disks, insert the firmware upgrade floppy disk into the floppy disk drive. If there is more than one floppy disk, insert firmware upgrade floppy disk number one into the floppy disk drive.
7. Power on the oscilloscope. The oscilloscope determines whether the firmware update is necessary. If no firmware update is necessary, the oscilloscope displays the following message:

“A floppy disk has been detected which contains instrument firmware. However, the firmware on the disk is not newer than the instrument firmware.

Push **MENU OFF** to remove this message”

Push the **MENU OFF** button and then go to step 10.

If a firmware update is necessary, the oscilloscope displays the following message:

“This procedure will replace the firmware in the instrument with firmware from the floppy disk. Do not turn the instrument off or eject the floppy disk until the procedure is complete. This procedure will take approximately 7 minutes.

Push ‘OK Load New Firmware’ to proceed.”

8. Push **OK Load New Firmware** to begin loading the firmware. The oscilloscope shows a clock icon on the screen while the firmware upgrade is in process. If a second firmware floppy disk is required, the oscilloscope will instruct you to eject the first disk and insert the second disk.

When the firmware upgrade is complete, the oscilloscope will restart automatically with the new firmware.

---

**NOTE.** *If you power off the oscilloscope, eject the floppy disk, or there is a power outage during the firmware upgrade process, you must power off the oscilloscope and repeat the firmware upgrade procedure, starting at step 6, before you can use the oscilloscope.*

---

9. If you do not want to upgrade the firmware, push **MENU OFF**.

---

**NOTE.** *If you do not update the oscilloscope firmware, the new application module may not function at all, or may not function correctly. It is strongly recommended that you install new firmware.*

---

10. Do not forget to remove the floppy disk when you are done with the firmware upgrade.

You are done installing the application module and firmware.

## Checking Module Installation

Do these steps to check that the Advanced Trigger application module is correctly installed. If the oscilloscope does not show the application module menu items, do the steps in *Troubleshooting Module Installation*.

1. Power on the oscilloscope. Look at the oscilloscope startup screen; it should list the newly-installed module. If the oscilloscope displays a message stating that you need to upgrade firmware, power off the oscilloscope and do the steps in the *Firmware Upgrade Procedure*, starting at step 6 on page 3.
2. Push the Trigger **MENU** button.
3. Push the **Type** bottom screen button. The pop-up menu now includes Logic and Pulse entries.



## Troubleshooting Module Installation

If the oscilloscope does not recognize the application module at power-up, do these steps:

1. Turn off the oscilloscope.
2. Follow the ESD precautions listed on page iv.
3. Remove the application module (refer to step 4 on page 2).
4. Examine the oscilloscope and application module contacts for damage.
5. Reinsert the application module into the oscilloscope.
6. Turn on the oscilloscope. If the oscilloscope does not display the application menu items as listed in *Checking Module Installation*, power off the oscilloscope and reinstall the application module into a different slot.
7. Turn on the oscilloscope. If the oscilloscope now shows the application module menu items, you have a problem with one of the application module slots. Contact the nearest Tektronix service center to resolve the problem.

If the oscilloscope does not show the application menu items, power off the oscilloscope and reinstall the oscilloscope firmware by starting at step 6 on page 3 (*Installing Application Module and Firmware*).

8. If, after reinstalling the firmware, the oscilloscope still does not show the application module menu items, contact the nearest Tektronix service center.



# Operating Basics

This chapter describes the features of the module, how to access the advanced trigger menu, and logic triggering concepts.

## Advanced Trigger Features

The TDS3TRG Advanced Trigger application module adds logic and pulse triggering capabilities to your TDS3000 series oscilloscope. This section provides an overview of these new features.

### Logic Trigger Features

Logic triggering triggers the oscilloscope when two signals meet a Boolean logic condition. The advanced trigger module provides pattern and state logic trigger modes.

**Pattern Trigger.** Pattern triggering triggers the oscilloscope when two signals become logically true or false. Basically, the pattern-triggering feature triggers the oscilloscope from the output of a two-input AND, OR, NAND, or NOR logic gate. You can specify time constraints and signal threshold levels as part of the triggering condition. This trigger is useful for digital logic troubleshooting.

**State Trigger.** State triggering triggers the oscilloscope when a state signal is true or false at the time a clock signal transition is true. This trigger is useful for troubleshooting digital logic synchronous state machines.

## Pulse Trigger Features

Pulse triggering triggers the oscilloscope when a signal meets a timing or threshold condition. The advanced trigger module provides three pulse trigger modes: pulse width, runt pulse, and slew rate.

**Pulse Width.** Pulse-width triggering triggers the oscilloscope when a signal pulse width is less than, greater than, equal to, or not equal to a specified pulse width. This trigger is useful for digital logic troubleshooting.

**Runt Pulse.** Runt-pulse triggering triggers the oscilloscope when a signal pulse is less than a specified threshold level. You can also specify runt pulse-width parameters. This trigger is useful for troubleshooting bus-contention problems.

**Slew Rate.** Slew-rate triggering triggers the oscilloscope when a signal's slew rate (rise or fall time) is less than, greater than, equal to, or not equal to a specified slew rate. This trigger is useful for troubleshooting digital bus transceivers, transmission lines, and op-amp circuits.

## Accessing Advanced Triggering

Do these steps to access the advanced triggering functions:

1. If B triggering is enabled, push the **B TRIG** button to turn off B triggering. You cannot use B triggering with any of the advanced trigger functions.
2. Push the Trigger **MENU** button to display the Trigger screen buttons.
3. Push the **Type** bottom screen button to display the trigger type pop-up menu.
4. Push the **Type** bottom screen button to select Logic or Pulse triggering.
5. Push the **Class** screen button to select trigger class.

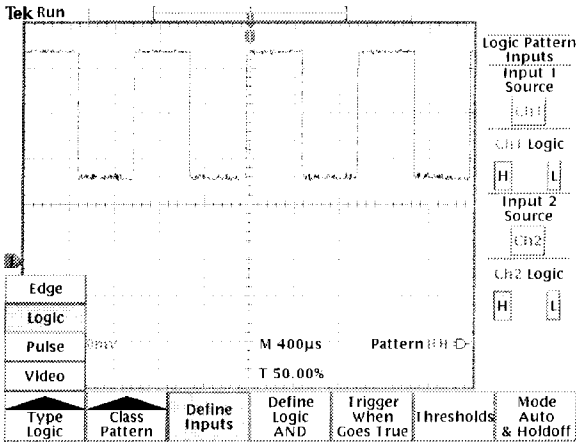

## Advanced Trigger Concepts

This section introduces the concepts of signal logic and thresholds as they relate to advanced triggering. These concepts apply to most or all of the advanced trigger functions. You should read this section if you are not familiar with advanced triggering concepts or Boolean logic.

### Overview

Edge triggering can trigger on most signals, and is the default trigger type. Edge triggering sets the oscilloscope to trigger (acquire signal data) when a signal meets a specified signal slope and a single voltage-threshold condition.

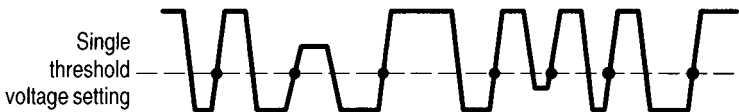

- = Possible trigger points for positive slope signals

However, there are times when you need to trigger the oscilloscope on a more complex signal, or when two signals meet a condition, in order to troubleshoot a particular problem. These problems include a pulse that is too narrow or wide, and situations in which one signal is true when a second signal transitions from low to high.

Advanced triggering can help acquire signals with these types of problems. Advanced triggering lets you further qualify the trigger conditions by adding parameters such as pulse width, delta time, logical comparisons of two signals, and dual threshold levels.

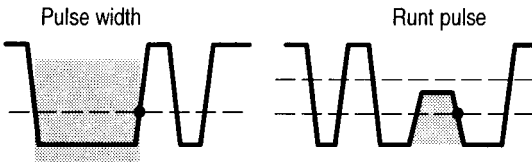

● = Trigger point

### Thresholds

Both pulse and logic triggering trigger the oscilloscope when one or two signals are logically true. To determine whether a signal is true or false, you must set a signal reference point that determines whether a signal is in one of two states. You set this reference point by specifying a threshold voltage level for each trigger signal. Crossing the threshold level toggles the state value of that signal.

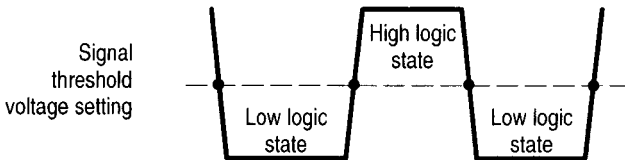

● = Transition point from one state to another

## Logic State

The actual state (true or false) of a signal depends on how you define its signal logic setting, which can be either high-true or low-true. Defining a signal as high-true (H) means that signal levels above (more positive than) the threshold level are true, and signal levels below (more negative than) the threshold level are false.

A low-true (L) logic setting is just the opposite. Defining a signal as low-true means that signal levels below (more negative than) the threshold level are true, and signal levels above (more positive than) the threshold level are false. Low logic effectively inverts the signal.

Defining the logical state of a signal lets you use Boolean logic to evaluate when a condition is true for two signals.

High-true logic

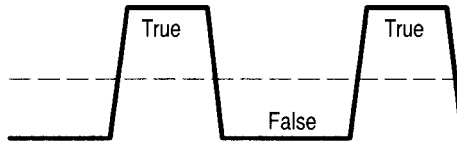

Low-true logic

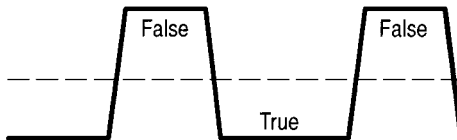

### **Boolean Logic**

The signal logic (threshold level and high-true/low-true logic) defines which part of a waveform cycle is true or false. You then use Boolean logic to evaluate or compare the logic of two signals as part of a trigger condition.

The four logical comparison functions are AND, OR, NAND, and NOR:

- The AND function means that if both signal logic states are true, the condition is true, otherwise the condition is false.
- The OR function means if either or both signal logic states are true, the condition is true, otherwise the condition is false.
- The NAND (Not-AND) function means that if both signal logic states are true, the condition is false, otherwise the condition is true. This function is the inverse of the AND function.
- The NOR (Not-OR) function means if any or all of the trigger signal logic states are true, the condition is false, otherwise the condition is true. This function is the inverse of the OR function.



The standard method of showing Boolean logic functions is the truth table. The truth table lists all possible signal logic states and the resulting Boolean evaluation (true or false). The following truth table lists the Boolean logic for two signals for all available advanced trigger logic functions (AND, NAND, OR, NOR).

Signal 1 logic state	Signal 2 logic state	Signal 1 AND Signal 2	Signal 1 NAND Signal 2	Signal 1 OR Signal 2	Signal 1 NOR Signal 2
False	False	False	True	False	True
True	False	False	True	True	False
False	True	False	True	True	False
True	True	True	False	True	False

Remember that the logic function evaluates the logic states of two signals, and that the logic state of each signal depends on whether they are set to high-true or low-true logic.

For example, assume that you want to trigger the oscilloscope only when signal one is low at the same time that signal two is high. Therefore you want to:

- Set a threshold level that is appropriate for each signal.
- Set signal one to be true when it is low (low-true signal logic).
- Set signal two to be true when the signal is high (high-true signal logic).
- Trigger when both conditions are true (AND trigger logic).

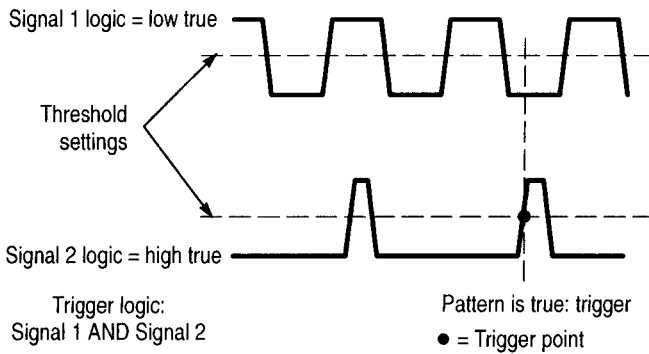

The material you have just read provides a basic understanding of the triggering concepts you need in order to use the Logic and Pattern triggering functions. Refer to the *Reference* section for detailed information about the advanced trigger functions.



## Reference

The advanced trigger module provides two types of triggering: logic and pulse. Logic triggering triggers the oscilloscope when the logical condition of two signals is true. Pulse triggering triggers the oscilloscope when a signal meets a timing or threshold condition.

## Conventions

The following conventions apply to all advanced trigger functions:

- You cannot use any of the advanced trigger functions to arm B triggering.
- You do not have to display a channel in order to use the channel as a trigger source.
- The range of time values for pulse width (regular and runt) and slew rate is from 39.6 ns to 10 s.
- In the menu tables,  $N$  represents a numeric value entered using the general purpose knob, or a value calculated by the oscilloscope (for example, slew rate).

## Pattern Triggering

In Pattern triggering, the oscilloscope monitors two signals. The oscilloscope triggers acquisition when the signals meet the specified Boolean logic conditions.

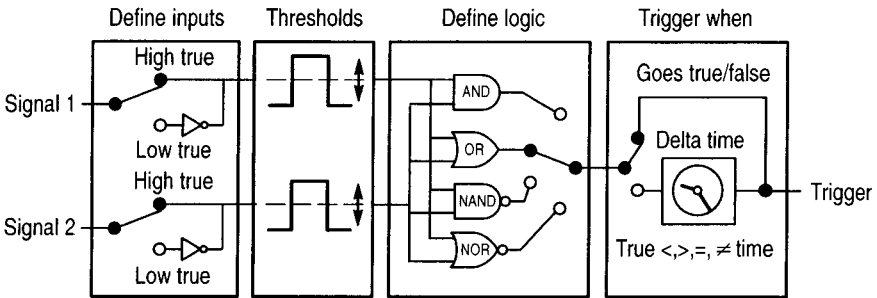

You can define the following pattern trigger parameters:

- The two input signals.
- The signal logic for each signal.
- The threshold level for each signal.
- The Boolean logic function used to compare the two signals.
- When to trigger. The oscilloscope can be set to trigger when the Boolean condition is true or false, or is true for a specified time period.

### Pattern Trigger Menu

The following table describes the pattern trigger menu items.

#### Trigger Menu: Type = Logic, Class = Pattern

Bottom	Side	Description
Define Inputs	Input 1 Source	Sets the pattern trigger input 1 signal source.
	Logic	Sets the signal logic for input 1. H = high true, L = low true.
	Input 2 Source	Sets the pattern trigger input 2 signal source.
	Logic	Sets the signal logic for input 2. H = high true, L = low true.
Define Logic	AND, OR, NAND, NOR	Sets which logic function to apply to the input signals.
Trigger When	Goes True/ Goes False	Triggers the oscilloscope when the logic condition is true or false.
	Is True < <i>N</i>	Triggers the oscilloscope when the input logic condition is true for a time period greater than or less than the time period <i>N</i> .
	Is True > <i>N</i>	
	Is True = <i>N</i>	Triggers the oscilloscope when the input logic condition is true for a time period equal to or not equal to the time period <i>N</i> within a $\pm 5\%$ tolerance.
	Is True $\neq$ <i>N</i>	

**Trigger Menu: Type = Logic, Class = Pattern**

<b>Bottom</b>	<b>Side</b>	<b>Description</b>
Thresholds	Level (Input 1) <i>N</i>	Sets the threshold voltage level for input 1 and 2 to level <i>N</i> , using the general purpose knob.
	Level (Input 2) <i>N</i>	
	Set to TTL	Sets the threshold voltage to 1.4 V for both inputs.
	Set to ECL	Sets the threshold voltage to -1.3 V for both inputs.
	Set to 50%	Sets the threshold voltage level to 50% of each input's peak-to-peak value.
Mode & Holdoff	Auto (Untriggered Roll)	Enables free-running and roll-mode acquisitions.
	Normal	Triggers only on valid trigger events.
	Holdoff (time)	Sets the trigger holdoff time value to a specific time.
	Holdoff (% of record)	Sets trigger holdoff to a percent of the record duration.
	Set to Min	Sets trigger holdoff value to the minimum value.

**Key Points**

**Trigger When.** The input condition must be true or false for  $\geq 2$  ns in order for the oscilloscope to detect the pattern.

### Pattern Triggering Example #1

In this example, you want to trigger the oscilloscope when channel 1 is high and channel 4 is low for a period of 12 ms  $\pm$  5%. Both inputs are TTL signals. Set the Pattern Trigger parameters as listed in the table:

**Trigger Menu: Type = Logic, Class = Pattern**

Bottom	Side	Value
Define Inputs	Input 1 Source Input 1 Logic Input 2 Source Input 2 Logic	Ch1 H Ch4 L
Define Logic	AND	
Trigger When	Is True =	12 ms
Thresholds	Set to TTL	

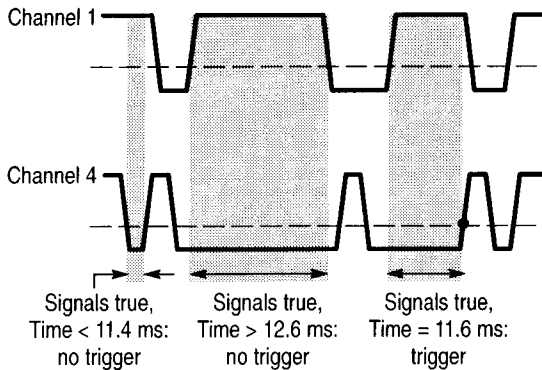

● = Trigger point

**Pattern Triggering Example #2**

In this example, you have two signals that are normally in phase. You suspect that the signal on channel 1 is dropping one or two cycles, and want to trigger the oscilloscope on the missing cycle. Set the Pattern Trigger parameters as listed in the table:

**Trigger Menu: Type = Logic, Class = Pattern**

Bottom	Side	Value
Define Inputs	Input 1 Source Input 1 Logic Input 2 Source Input 2 Logic	Ch1 L Ch2 H
Define Logic	AND	
Trigger When	Goes True	
Thresholds	Level (Input 1) Level (Input 2)	2.5 V 2.5 V

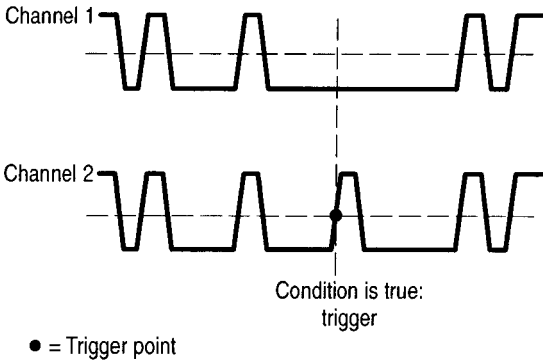



## State Triggering

With state triggering, the oscilloscope monitors the first signal (referred to here as a clock) for a specified transition slope and voltage threshold condition. When the clock transition is true, the oscilloscope then checks the second input signal (called the state input) level. If the state input signal is true, the oscilloscope is triggered. In other words, the oscilloscope triggers when the clock input transition is true, and the state input signal is true. The oscilloscope can also trigger when the clock transition is true, but the state signal is false.

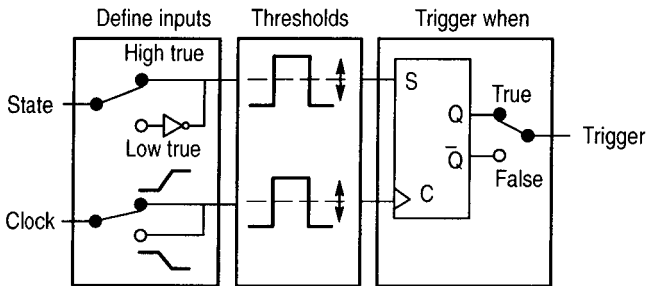

You can define the following state trigger parameters:

- The two signal sources (state and clock).
- The state signal logic: H (high true) or L (low true).
- Whether to clock on low to high transitions, or clock on high to low transitions.
- The signal threshold voltage level for both signals.
- When to trigger. The oscilloscope can be set to trigger when the state condition is true or false.

### State Trigger Menu

The following table describes the state trigger menu items.

#### Trigger Menu: Type = Logic, Class = State

Bottom	Side	Description
Define Inputs	State Input Source	Sets the state signal source.
	Logic	Sets the signal logic for state input. H = high true, L = low true.
	Clock Input Source	Sets the clock signal source.
	Slope	Sets the signal slope (rising or falling) for the clock input source. The clock slope defines when the clock signal is true.
Trigger When	Goes True	Triggers the oscilloscope if the state signal is true when the clock signal slope is true.
	Goes False	Triggers the oscilloscope if the state signal is false when the clock signal slope is true.

#### Key Point

**Trigger When Goes True/Goes False.** The state signal must be true or false for  $\geq 2$  ns prior to the clock transition in order for the oscilloscope to detect the state.

**Trigger Menu: Type = Logic, Class = State**

Bottom	Side	Description
Thresholds	Level (State Input) <i>N</i>	Sets the threshold voltage level for state and clock signals to level <i>N</i> .
	Level (Clock Input) <i>N</i>	
	Set to TTL	Sets the threshold voltage to 1.4 V for both inputs.
	Set to ECL	Sets the threshold voltage to -1.3 V for both inputs.
	Set to 50%	Sets the threshold voltage level to 50% of each input's peak-to-peak value.
Mode & Holdoff		Refer to description on page 18.

**Key Point**

**State Input Transition.** The state input must make a transition from false to true prior to the clock input edge. No additional clock input edges are recognized until the state input transitions.

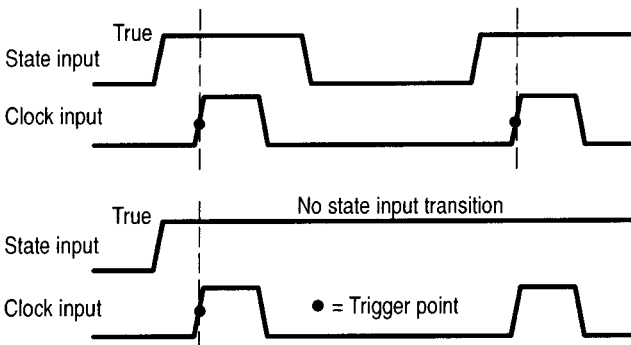

### State Triggering Example

In this example, you want to trigger the oscilloscope if channel 1 is high when channel 3 goes from high to low (falling slope). The channel 1 signal is ECL logic, and the channel 3 signal is TTL logic. Set the state trigger parameters as listed in the table:

**Trigger Menu: Type = Logic, Class = State**

Bottom	Side	Value
Define Inputs	State Input Source State Logic Clock Input Source Clock Slope	Ch1 H Ch3 \
Trigger When	Goes True	
Thresholds	Level (State Input) Level (Clock Input)	-1.3 V 1.4 V

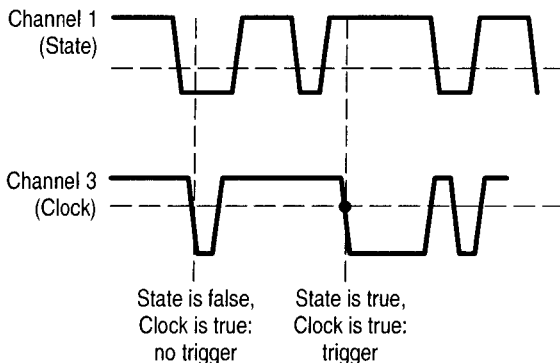

● = Trigger point

## Pulse Width Triggering

Pulse-width triggering triggers the oscilloscope when the width of a signal pulse is less than, greater than, equal to, or not equal to a specified width. The pulse-width measurement is from threshold transition to threshold transition.

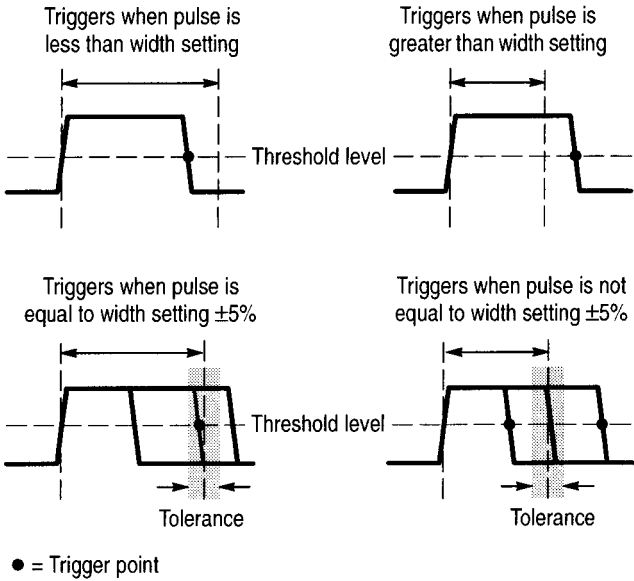

### Pulse Width Trigger Menu

The following table lists the pulse width trigger menu items.

#### Trigger Menu: Type = Pulse, Class = Width

Bottom	Side	Description
Source	Ch1 - Ch4	Sets the pulse width signal source.
	Ext	Sets external or external divided by 10 as the signal source. These sources are only available on two-channel models.
	Ext/10	
	AC Line	Sets the AC line frequency as the trigger source. This trigger source is only available when the oscilloscope is connected to AC power.
	Vert	Sets the lowest-numbered displayed channel as the trigger source.
Polarity	Positive	Sets the source signal pulse polarity on which to trigger.
	Negative	
Trigger When	Pulse Width < $N$	Triggers the oscilloscope when the source signal pulse width is less than or greater than the specified pulse width $N$ .
	Pulse Width > $N$	
	Pulse Width = $N$	Triggers the oscilloscope when the signal pulse width is equal to or not equal to the specified pulse width $N$ within a $\pm 5\%$ tolerance.
	Pulse Width $\neq N$	

**Trigger Menu: Type = Pulse, Class = Width**

Bottom	Side	Description
Level	Level <i>N</i>	Sets the signal threshold voltage level to <i>N</i> using the general purpose knob.
	Set to TTL	Sets the signal threshold voltage to 1.4 V.
	Set to ECL	Sets the signal threshold voltage to -1.3 V.
	Set to 50%	Sets the threshold voltage level to 50% of the input's peak-to-peak value.
Mode & Holdoff		Refer to description on page 18.

**Key Points**

**Trigger When.** The source pulse width must be  $\geq 5$  ns in order for the oscilloscope to detect the pulse.

### Pulse Width Triggering Example

In this example, you suspect that a clock signal occasionally deviates from its normal pulse width of 60 ns, thus causing timing problems. You want to trigger the oscilloscope when the signal pulse-width on channel 2 does not equal  $60\text{ ns} \pm 5\%$ . Set the pulse width parameters as listed in the table:

**Trigger Menu: Type = Pulse, Class = Width**

Bottom	Side	Setting
Source	Ch2	
Polarity	Positive	
Trigger When	Pulse Width $\neq$	60 ns
Level	Set to 50%	

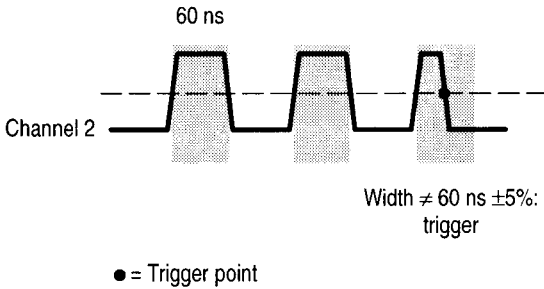



## Runt Pulse Triggering

A runt pulse is a signal that recrosses a first threshold level before crossing a second threshold level. A positive runt pulse is a signal that first recrosses the low threshold level; a negative runt pulse is a signal that first recrosses the high threshold level.

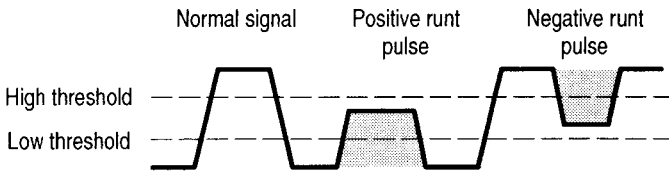

You can trigger on the following runt pulse conditions:

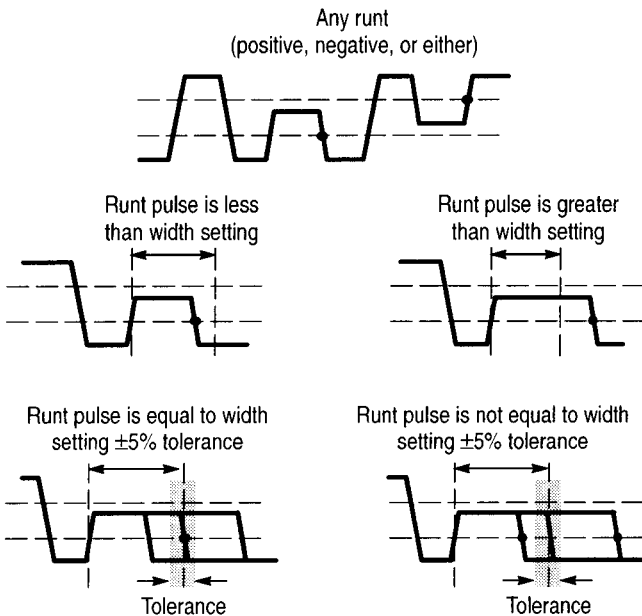

• = Trigger point

### Runt Pulse Trigger Menu

The following table describes the runt pulse trigger menu items.

#### Trigger Menu: Type = Pulse, Class = Runt

Bottom	Side	Description
Source	Ch1 - Ch4	Sets the runt signal source.
	Ext	Same as descriptions on page 26.
	Ext/10	
	AC Line	
	Vert	
Polarity	Positive	Sets the source signal runt pulse polarity on which to trigger.
	Negative	
	Either	
Trigger When	Runt Occurs	Triggers the oscilloscope when any runt pulse is detected, regardless of width.
	Runt Width < $N$	Triggers the oscilloscope when the runt signal pulse width is less than or greater than the specified pulse width $N$ .
	Runt Width > $N$	
	Runt Width = $N$	Triggers the oscilloscope when the runt signal pulse width is equal to or not equal to the specified pulse width $N$ within a $\pm 5\%$ tolerance.
	Runt Width $\neq N$	

**Trigger Menu: Type = Pulse, Class = Runt**

Bottom	Side	Description
Thresholds	High <i>N</i>	Sets the runt signal high threshold and low threshold voltage levels to value <i>N</i> , using the general purpose knob.
	Low <i>N</i>	
	Set to TTL	Sets the runt signal threshold voltage levels to 2.0 V (high threshold) and 0.8 V (low threshold).
	Set to ECL	Sets the runt signal threshold voltage levels to -1.1 V (high threshold) and -1.5 V (low threshold).
Mode & Holdoff		Refer to description on page 18.

**Key Points**

**Trigger When.** The source runt pulse width must be  $\geq 5$  ns in order for the oscilloscope to detect the pulse.

### Runt Pulse Triggering Example

In this example, you suspect that two signals are trying to drive a data bus line at the same time, preventing an ECL-logic data line from reaching a logic high level. You want to trigger the oscilloscope when the signal peak-to-peak range on channel 1 is less than ECL logic (a runt pulse trigger). Set the runt-pulse trigger parameters as listed in the table:

#### Trigger Menu: Type = Pulse, Class = Runt

Bottom	Side
Source	Ch1
Polarity	Positive
Trigger When	Runt Occurs
Thresholds	Set to ECL

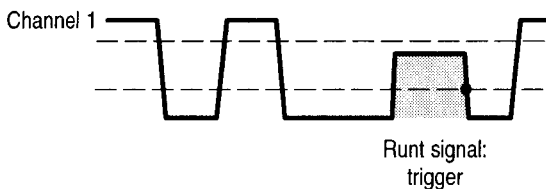

● = Trigger point

## Slew Rate Triggering

A slew-rate trigger occurs when the trigger source detects a pulse edge that traverses (slews) between two amplitude levels at a rate faster than or slower than you specify. You can also think of slew-rate triggering as triggering based on the slope (the change in signal voltage divided by the change in time) of a pulse edge (rise/fall time).

The oscilloscope can trigger on positive or negative slew rates. The combination of high and low threshold levels and delta time determine the slew-rate setting.

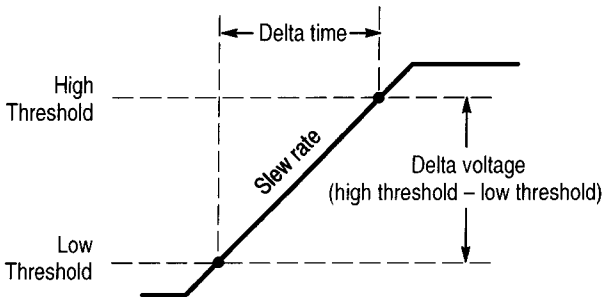

$$\text{Slew rate} = \text{Delta voltage} \div \text{Delta time}$$

You can set the oscilloscope to trigger on the following slew rate conditions (for positive and/or negative signal slopes):

Signal slew rate is greater (faster) than specified slew rate

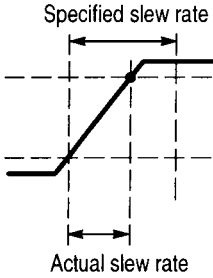

Signal slew rate is less (slower) than specified slew rate

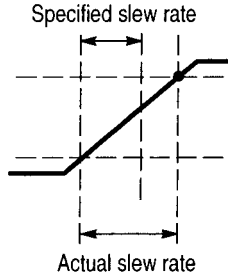

Signal slew rate is equal to specified slew rate within  $\pm 5\%$  tolerance

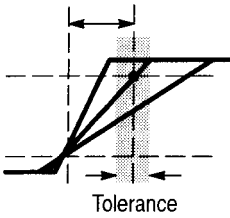

Signal slew rate is not equal to specified slew rate within  $\pm 5\%$  tolerance

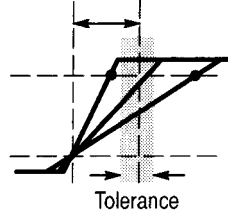

● = Trigger point

## Slew Rate Trigger Menu

The following table lists the slew rate trigger menu items.

### Trigger Menu: Type = Pulse, Class = Slew Rate

Bottom	Side	Description
Source	Ch1 - Ch4	Sets the slew rate signal source.
	Ext	Same as descriptions on page 26.
	Ext/10	
	AC Line	
	Vert	
Polarity	Positive	Sets the source signal slew rate polarity on which to trigger.
	Negative	
	Either	
Trigger When	Slew Rate < $N$	Triggers the oscilloscope when the signal slew rate is less than or greater than the calculated slew rate $N$ .
	Slew Rate > $N$	
	Slew Rate = $N$	Triggers the oscilloscope when the signal slew rate is equal to or not equal to the calculated slew rate $N$ within a $\pm 5\%$ tolerance.
	Slew Rate $\neq N$	
	Delta Time $N$	Sets the delta time component of the slew rate value to time $N$ , using the general purpose knob.

**Trigger Menu: Type = Pulse, Class = Slew Rate**

Bottom	Side	Description
Thresholds	High <i>N</i>	Sets the signal high threshold and low threshold voltage level components of the slew rate to value <i>N</i> , using the general purpose knob.
	Low <i>N</i>	
	Set to TTL	Sets the threshold voltage level components of the slew rate to 2.0 V (high threshold) and 0.8 V (low threshold).
	Set to ECL	Sets the threshold voltage level components of the slew rate to -1.1 V (high threshold) and -1.5 V (low threshold).
Mode & Holdoff		Refer to description on page 18.

**Key Points**

**Delta Time and Thresholds.** The delta time and threshold settings determine the calculated slew rate (volts ÷ time). Changing either value changes the calculated slew rate.

**Trigger When.** The delta time component of the slew rate (time from threshold to threshold) must be  $\geq 5$  ns in order for the oscilloscope to detect the slew rate.



### Slew Rate Triggering Example

In this example, you suspect that circuit timing is causing an intermittent, metastable condition on the channel 2 signal. You want to find out when the slew rate is less (slower) than 54 mV/ns from threshold to threshold. Set the slew-rate trigger parameters as listed in the table:

**Trigger Menu: Type = Pulse, Class = Slew Rate**

Bottom	Side	Setting
Source	Ch2	
Polarity	Positive	
Trigger When	Slew Rate <	
	Delta time	50 ns
Thresholds	High	3.5 V
	Low	0.8 V

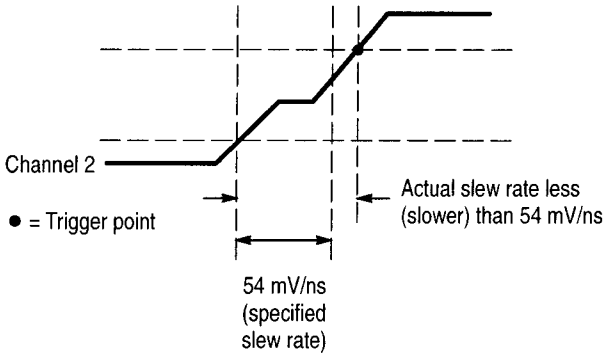

# Appendix A: Specifications

This appendix describes the TDS3TRG Advanced Trigger application module specifications. All specifications are guaranteed unless labeled "typical." Typical specifications are provided for your convenience but are not guaranteed.

To meet specifications, two conditions must first be met:

- The oscilloscope must have been operating continuously for ten minutes within the operating temperature range specified.
- You must perform the Compensate Signal Path operation described in the *TDS3000 Series Digital Phosphor Oscilloscope User Manual*. If the operating temperature changes by more than 10° C, you must perform the Compensate Signal Path operation again.

**Table 1: TDS3TRG Advanced Trigger application module specifications**

Characteristic	Description	
Logic and Pulse Trigger Sensitivity, typical	1.0 division at BNC, DC Coupled, $\geq 10$ mV/div to $\leq 1$ V/div (pattern, state, delay, width, and runt triggering)	
Slew Rate Trigger Sensitivity, typical	Same as Edge Trigger Sensitivity specifications in Appendix A of the <i>TDS3000 Series Digital Phosphor Oscilloscope User Manual</i> .	
Logic Triggering Minimum Logic Time, typical	<i>Pattern</i>	<i>State</i>
	2 ns	2 ns
	Pattern minimum logic time: the time that a logic pattern must be valid to be recognized. State minimum logic time: the time that a logic state must be valid before and after the clock edge to be recognized.	

**Table 1: TDS3TRG Advanced Trigger application module specifications (cont.)**

Characteristic	Description	
Logic Triggering Minimum Rearm Time, typical	<i>Pattern</i>	<i>State</i>
	2 ns	4 ns
	Pattern minimum rearm time: the time that a logic pattern must be invalid before a new occurrence of the pattern is recognized. State minimum rearm time: the time between consecutive clocks.	
Pulse Triggering Minimum Pulse Width, typical	5 ns For pulse and runt, minimum pulse width refers to the pulse being measured. For slew rate, minimum pulse width means the minimum delta time that the oscilloscope recognizes.	
Pulse Triggering Minimum Rearm Time, typical	5 ns For pulse and runt, rearm time refers to the time between measured pulses. For slew rate, rearm time refers to the time it takes the signal to recross the two signal thresholds.	
Delta Time Resolution using general purpose knob	<i>Time Range</i>	
	39.6 ns to 9.99 $\mu$ s	
	10 $\mu$ s to 99.9 $\mu$ s	
	100 $\mu$ s to 999 $\mu$ s	
	1 ms to 9.99 ms	
	10 ms to 99.9 ms	
	100 ms to 999 ms	
	1 s to 10 s	
<i>Resolution</i>		
13.2 ns		
92.4 ns		
1 $\mu$ s		
10 $\mu$ s		
100 $\mu$ s		
1 ms		
10 ms		



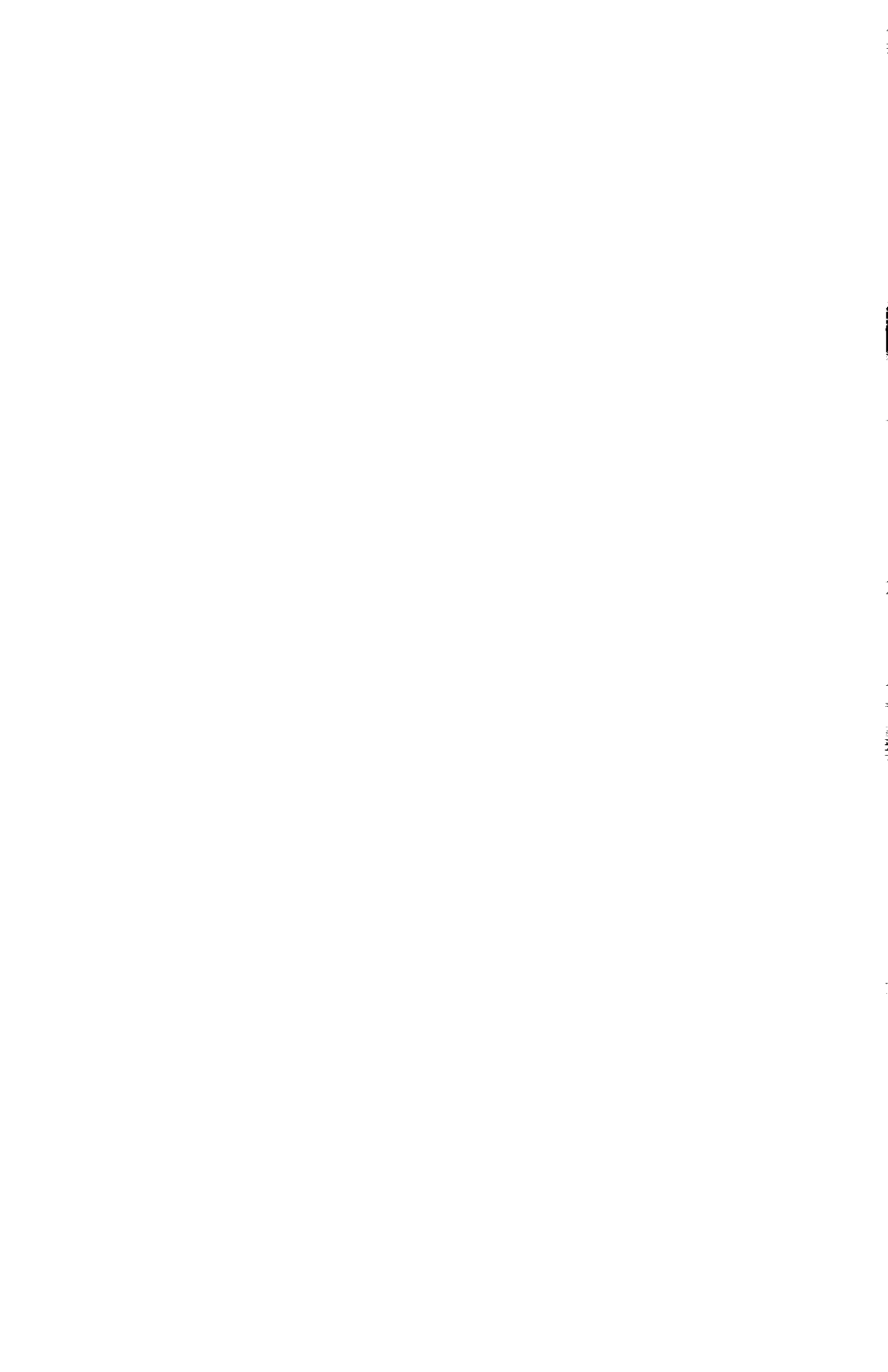



Printed on recyclable paper. Please recycle.

# User Manual

**Tektronix**



**TDS3FFT**  
**FFT Application Module**

**071-0305-01**



071030501

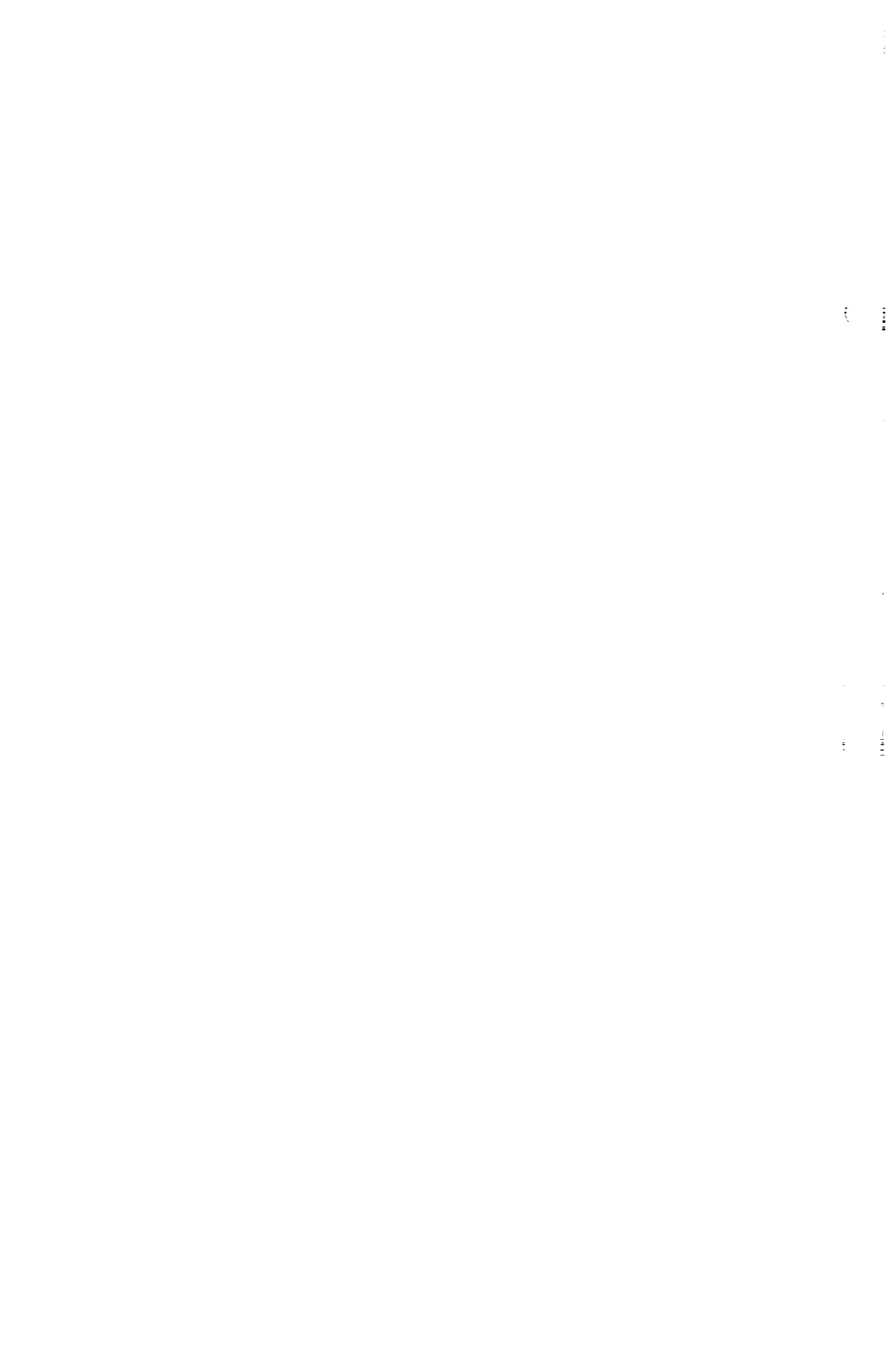



# **User Manual**

**Tektronix**

**TDS3FFT**  
**FFT Application Module**  
**071-0305-01**

This document supports firmware version 2.00  
and above.

Copyright © Tektronix, Inc. All rights reserved.

Tektronix products are covered by U.S. and foreign patents, issued and pending. Information in this publication supercedes that in all previously published material. Specifications and price change privileges reserved.

Printed in the U.S.A.

Tektronix, Inc., P.O. Box 1000, Wilsonville, OR 97070-1000

TEKTRONIX and TEK are registered trademarks of Tektronix, Inc.

DPX is a trademark of Tektronix, Inc.

## **WARRANTY SUMMARY**

Tektronix warrants that the products that it manufactures and sells will be free from defects in materials and workmanship for a period of three (3) years from the date of shipment from an authorized Tektronix distributor. If a product or CRT proves defective within the respective period, Tektronix will provide repair or replacement as described in the complete warranty statement.

To arrange for service or obtain a copy of the complete warranty statement, please contact your nearest Tektronix sales and service office.

**EXCEPT AS PROVIDED IN THIS SUMMARY OR THE APPLICABLE WARRANTY STATEMENT, TEKTRONIX MAKES NO WARRANTY OF ANY KIND, EXPRESS OR IMPLIED, INCLUDING WITHOUT LIMITATION THE IMPLIED WARRANTIES OF MERCHANTABILITY AND FITNESS FOR A PARTICULAR PURPOSE. IN NO EVENT SHALL TEKTRONIX BE LIABLE FOR INDIRECT, SPECIAL OR CONSEQUENTIAL DAMAGES.**





# Table of Contents

<b>General Safety Summary</b> .....	<b>iii</b>
<b>Preface</b> .....	<b>v</b>
Contacting Tektronix .....	vi

## Getting Started

Installing Application Module and Firmware .....	1
Checking Module Installation .....	4
Troubleshooting Module Installation .....	5

## Operating Basics

Introduction .....	6
FFT Features .....	7
Displaying an FFT Waveform .....	8
Measurement Concepts .....	9

## Reference

FFT Menu .....	16
FFT Example 1 .....	20
FFT Example 2 .....	22



# General Safety Summary

Review the following safety precautions to avoid injury and prevent damage to this product or any products connected to it. To avoid potential hazards, use this product only as specified.

*Only qualified personnel should perform service procedures.*

While using this product, you may need to access other parts of the system. Read the *General Safety Summary* in other system manuals for warnings and cautions related to operating the system.

## To Avoid Fire or Personal Injury

**Do Not Operate With Suspected Failures.** If you suspect there is damage to this product, have it inspected by qualified service personnel.

**Do Not Operate in Wet/Damp Conditions.**

**Do Not Operate in an Explosive Atmosphere.**

## Safety Terms and Symbols

**Terms in This Manual.** The following term appears in this manual:



---

**CAUTION.** *Caution statements identify conditions or practices that could result in damage to this product or other property.*

---

## Preventing Electrostatic Damage



---

**CAUTION.** *Electrostatic discharge (ESD) can damage components in the oscilloscope and its accessories. To prevent ESD, observe these precautions when directed to do so.*

---

**Use a Ground Strap.** Wear a grounded antistatic wrist strap to discharge the static voltage from your body while installing or removing sensitive components.

**Use a Safe Work Area.** Do not use any devices capable of generating or holding a static charge in the work area where you install or remove sensitive components. Avoid handling sensitive components in areas that have a floor or benchtop surface capable of generating a static charge.

**Handle Components Carefully.** Do not slide sensitive components over any surface. Do not touch exposed connector pins. Handle sensitive components as little as possible.

**Transport and Store Carefully.** Transport and store sensitive components in a static-protected bag or container.





# Preface

This User Manual describes the capabilities, operation, and applications of the TDS3FFT FFT application module. The following table shows you where to find information in this manual.

<b>If you are looking for:</b>	<b>Turn to:</b>
Installation information	<i>Installing Application Module and Firmware</i> on page 1
Product overview	<i>FFT Features</i> on page 6
Basic operating instructions	<i>Displaying an FFT Waveform</i> on page 8
Understanding FFT Measurements	<i>Measurement Concepts</i> on page 9
Function details	<i>Reference</i> section starting on page 16

## Contacting Tektronix

Product Support	<p>For questions about using Tektronix measurement products, call toll free in North America: 1-800-TEK-WIDE (1-800-835-9433 ext. 2400) 6:00 a.m. – 5:00 p.m. Pacific time</p> <p>Or contact us by e-mail: tm_app_supp@tektronix.com</p> <p>For product support outside of North America, contact your local Tektronix distributor or sales office.</p>
Service Support	<p>Tektronix offers extended warranty and calibration programs as options on many products. Contact your local Tektronix distributor or sales office.</p> <p>For a listing of worldwide service centers, visit our web site.</p>
For other information	<p>In North America: 1-800-TEK-WIDE (1-800-835-9433) An operator will direct your call.</p>
To write us	<p>Tektronix, Inc. P.O. Box 1000 Wilsonville, OR 97070-1000 USA</p>
Website	<p>Tektronix.com</p>

# Getting Started

This chapter describes how to install and check the TDS3FFT FFT application module.

## Installing Application Module and Firmware

You can install up to four application modules in the oscilloscope. Application modules go into the two slots with windows in the upper right corner of the front panel. Two additional slots are located behind the two front slots.

---

**NOTE.** *You do not need to do the following procedure if you purchased a four-channel oscilloscope with pre-installed application modules.*

*You must do the firmware install procedure the first time you install a new application module.*

*You do not need to reinstall the firmware if you remove and reinstall an application module.*

---



---

**CAUTION.** *To avoid damage to the oscilloscope or application module, observe the ESD precautions described on page iv.*

---

To install an application module and its associated oscilloscope firmware, do these steps:

1. Save any oscilloscope settings and/or reference waveforms to floppy disk before doing these steps.
2. Turn the oscilloscope power off.
3. Open the small door in the upper right corner of the front panel.
4. Slide the application module into any available slot with the module contacts facing the circuit board. Use a small screwdriver to remove an existing module if it is necessary to make space for a new application module.
5. Close the module door.

---

**NOTE.** If you remove an application module, the features provided by that application module are no longer available. You can reinstall the module to restore the features.

---

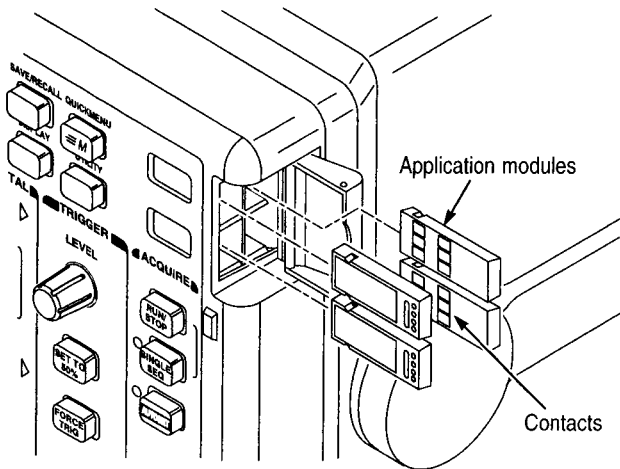

6. If the application module came with one or more floppy disks, insert the firmware upgrade floppy disk into the floppy disk drive. If there is more than one floppy disk, insert firmware upgrade floppy disk number one into the floppy disk drive.
7. Power on the oscilloscope. The oscilloscope determines whether the firmware update is necessary. If no firmware update is necessary, the oscilloscope displays the following message:

“A floppy disk has been detected which contains instrument firmware. However, the firmware on the disk is not newer than the instrument firmware.

Push **MENU OFF** to remove this message”

Push the **MENU OFF** button and then go to step 10.

If a firmware update is necessary, the oscilloscope displays the following message:

“This procedure will replace the firmware in the instrument with firmware from the floppy disk. Do not turn the instrument off or eject the floppy disk until the procedure is complete. This procedure will take approximately 7 minutes.

Push ‘OK Load New Firmware’ to proceed.”

8. Push **OK Load New Firmware** to begin loading the firmware. The oscilloscope shows a clock icon on the screen while the firmware upgrade is in process. If a second firmware floppy disk is required, the oscilloscope will instruct you to eject the first disk and insert the second disk.

When the firmware upgrade is complete, the oscilloscope will restart automatically with the new firmware.

---

**NOTE.** *If you power off the oscilloscope, eject the floppy disk, or there is a power outage during the firmware upgrade process, you must power off the oscilloscope and repeat the firmware upgrade procedure, starting at step 6, before you can use the oscilloscope.*

---

9. If you do not want to upgrade the firmware, push **MENU OFF**.

---

**NOTE.** *If you do not update the oscilloscope firmware, the new application module may not function at all, or may not function correctly. It is strongly recommended that you install new firmware.*

---

10. Do not forget to remove the floppy disk when you are done with the firmware upgrade.

You are done installing the application module and firmware.

## Checking Module Installation

Do these steps to check that the FFT application module is correctly installed. If the oscilloscope does not show the application module menu items, do the steps in *Troubleshooting Module Installation*.

1. Power on the oscilloscope. If the oscilloscope displays a message stating that you need to upgrade firmware, power off the oscilloscope and do the steps in the *Firmware Upgrade Procedure* on page 3, starting at step 6.
2. Look at the oscilloscope startup screen; it should list the newly-installed module.
3. Push the **MATH** button to display the Math menu that now includes an FFT button.
4. Push the **FFT** bottom button to show the FFT side menu items (Set FFT Source, Set FFT Vert Scale, and Set FFT Window).

## Troubleshooting Module Installation

If the oscilloscope does not recognize the application module at power-up, do these steps:

1. Turn off the oscilloscope.
2. Follow the ESD precautions listed on page iv.
3. Remove the application module (refer to step 4 on page 2).
4. Examine the oscilloscope and application module contacts for damage.
5. Reinsert the application module into the oscilloscope.
6. Turn on the oscilloscope. If the oscilloscope does not display the application menu items as listed in *Checking Module Installation*, power off the oscilloscope and reinstall the application module into a different slot.
7. Turn on the oscilloscope. If the oscilloscope now shows the application module menu items, you have a problem with one of the application module slots. Contact the nearest Tektronix service center to resolve the problem.

If the oscilloscope does not show the application menu items, power off the oscilloscope and reinstall the oscilloscope firmware by starting at step 6 on page 3 (*Installing Application Module and Firmware*).

8. If, after reinstalling the firmware, the oscilloscope still does not show the application module menu items, contact the nearest Tektronix service center.



# Operating Basics

This chapter describes the features of the module, how to access the FFT menu, and FFT measurement concepts.

## Introduction

The FFT application module adds FFT (Fast Fourier Transform) measurement capabilities to your TDS3000 series Digital Phosphor Oscilloscope. The FFT process mathematically converts the standard time-domain signal (repetitive or single-shot acquisition) into its frequency components, providing spectrum analysis capabilities.

Being able to quickly look at a signal's frequency components and spectrum shape is a powerful research and analysis tool. FFT is an excellent troubleshooting aid for:

- Testing impulse response of filters and systems
- Measuring harmonic content and distortion in systems
- Identifying and locating noise and interference sources
- Analyzing vibration
- Analyzing harmonics in 50 and 60 Hz power lines



## FFT Features

The FFT application module provides the following features:

### **FFT Windows**

Four FFT windows (Rectangular, Hamming, Hanning, and Blackman-Harris) let you match the optimum window to the signal you are analyzing. The Rectangular window is best for nonperiodic events such as transients, pulses, and one-shot acquisitions. The Hamming, Hanning, and Blackman-Harris windows are better for periodic signals.

### **Analyze Repetitive, Single-Shot, and Stored Waveforms**

You can display an FFT waveform on any actively-acquired signal (periodic or one-shot), the last acquired signal, or any signal stored in reference memory.

### **dB or Linear RMS Scales**

The FFT vertical graticule can be set to either dB or Linear RMS. A dB scale is useful when the frequency component magnitudes cover a wide dynamic range, letting you show both lesser and greater-magnitude frequency components on the same display. A Linear scale is useful when the frequency component magnitudes are all close in value, allowing direct comparison of their magnitudes.

### **Time Signals and FFT Waveforms Displayed Together**

The time signals and FFT waveforms can be shown together on the display. The time signal highlights the problem; the FFT waveform helps you determine the cause of the problem.

## Displaying an FFT Waveform

Do these steps to display an FFT waveform.

1. Set the source signal Vertical SCALE so that the signal peaks do not go off screen. Off-screen signal peaks can result in FFT waveform errors.
2. Set the Horizontal SCALE control to show five or more cycles of the source signal. Showing more cycles means the FFT waveform can show more frequency components, provide better frequency resolution, and reduce aliasing (refer to *Aliasing* on page 14 for more information).

If the signal is a single-shot (transient) signal, make sure that the entire signal (transient event and ringing or noise) is displayed and centered on the screen.

You cannot use FFT on XY signals.

3. Push the Vertical **MATH** button to show the math menu. Note that MATH is not available when using QuickMenu.
4. Push the **FFT** screen button to show the FFT side menu. The oscilloscope displays the FFT waveform for the last-selected FFT source.
5. Select the signal source (page 16). You can do an FFT on any channel or any stored reference waveform.
6. Select the appropriate vertical scale and FFT window (page 16).
7. Use zoom controls and the cursors to magnify and measure the FFT waveform (page 19).

## Measurement Concepts

This section introduces the concepts of measuring signal frequency components using an FFT process. You should read this section if you are not familiar with FFT measurement.

### FFT Process

As stated earlier, the FFT process mathematically converts the standard time-domain signal (repetitive or single-shot acquisition) into its frequency components. The FFT process uses the entire waveform record data starting from sample time zero to a maximum of 500 points (Fast Trigger) or 10,000 points (Normal).

The FFT function processes the waveform record and displays the FFT frequency domain record, which contains the input signal frequency components from DC (0 Hz) to  $\frac{1}{2}$  the sample frequency (also called the Nyquist frequency; refer to page 14).

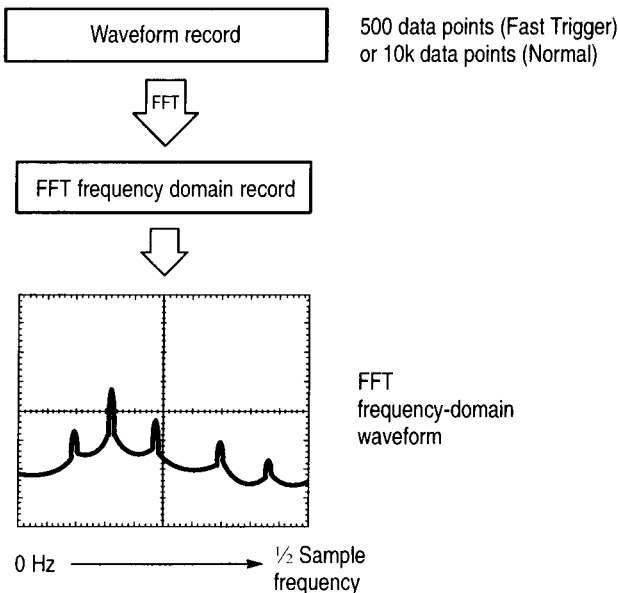

### The FFT Display

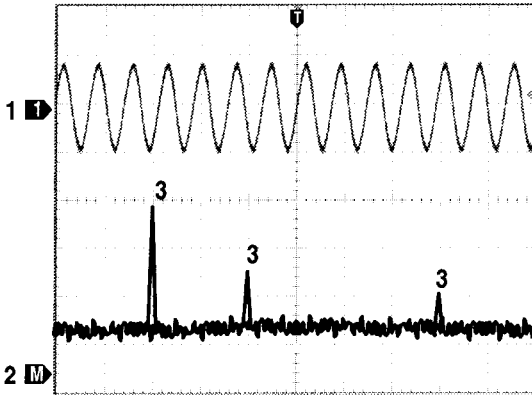

1. Source signal channel label
2. Math FFT waveform
3. Frequency components

### FFT Windows

The FFT process assumes that the part of the waveform record used for FFT analysis represents a repeating waveform that starts and ends at or near zero volts (in other words is an integer number of cycles). When a waveform starts and ends at the same amplitude, there are no artificial discontinuities in the signal shape, and both the frequency and amplitude information is accurate.

A non-integral number of cycles in the waveform record causes the waveform start and end points to be at different amplitudes. The transitions between the start and end points cause discontinuities in the waveform that introduce high-frequency transients. These transients add false frequency information to the frequency domain record.

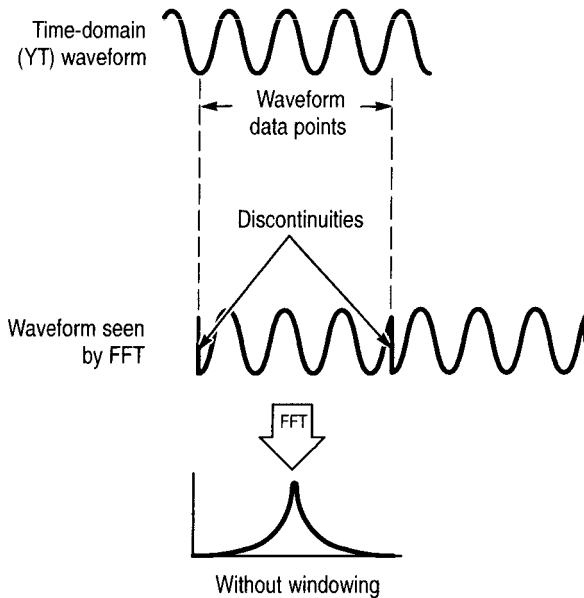

Applying a window function to the waveform record changes the waveform so that the start and stop values are close to each other, reducing the discontinuities. This results in an FFT measurement that more accurately reflects the actual signal frequency components. The 'shape' of the window determines how well it resolves frequency or magnitude information.

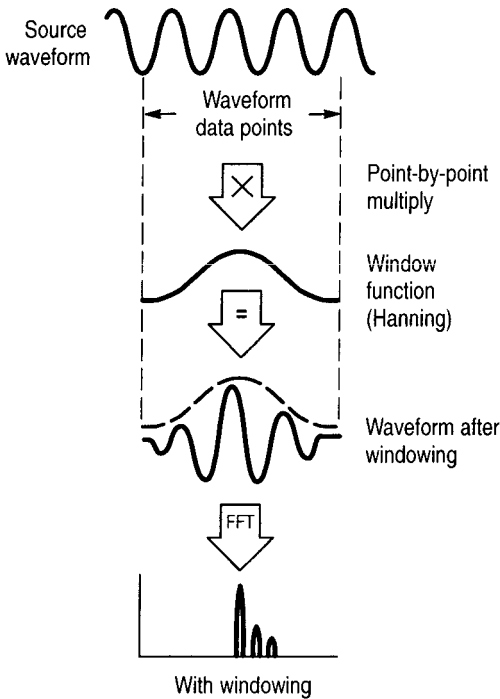

### FFT Window Characteristics

The FFT application module provides four FFT windows. Each window is a trade-off between frequency resolution and magnitude accuracy. What you want to measure, and your source signal characteristics, help determine which window to use. Use the following guidelines to select the best window.

FFT Window	Characteristics	Best for measuring
Rectangular	Best frequency, worst magnitude resolution. This is essentially the same as no window.	<p>Transients or bursts where the signal levels before and after the event are nearly equal.</p> <p>Equal-amplitude sine waves with frequencies that are very close.</p> <p>Broad-band random noise with a relatively slow varying spectrum.</p>
Hamming, Hanning	Better frequency, poorer magnitude accuracy than Rectangular. Hamming has slightly better frequency resolution than Hanning.	<p>Sine, periodic, and narrow-band random noise.</p> <p>Transients or bursts where the signal levels before and after the event are significantly different.</p>
Blackman-Harris	Best magnitude, worst frequency resolution.	Predominantly single frequency signals to look for higher order harmonics.

You can also determine the best window empirically by first selecting the Rectangular window, then selecting (in the following order) the Hamming, Hanning, and Blackman-Harris windows until the frequency components merge. Use the window just prior to where the frequencies merge for the best compromise between resolution and amplitude accuracy.

### Nyquist Frequency

The highest frequency that any digital oscilloscope can measure without errors is one-half the sample rate or frequency. This frequency is called the Nyquist frequency. The FFT waveform displays the input signal frequency components from DC (0 Hz) to the Nyquist frequency.

### Aliasing

Problems occur when the oscilloscope acquires a signal containing frequency components that are higher in frequency than the Nyquist frequency. The frequency components that are above the Nyquist frequency are undersampled and appear to “fold back” around the Nyquist frequency, showing as lower frequency components. These incorrect components are called aliases.

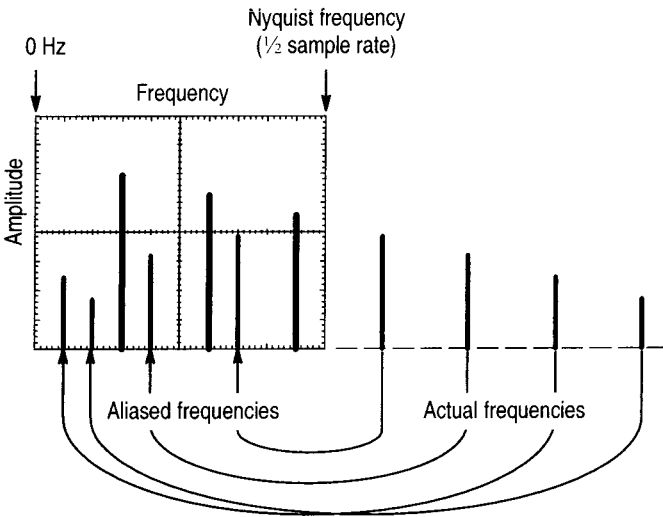



### **Eliminating Aliases**

Use the following methods to eliminate aliases:

- Increase the sample rate by adjusting the Horizontal SCALE to a faster frequency setting. Since you increase the Nyquist frequency as you increase the frequency, the aliased frequency components should appear at their proper frequency. If the increased number of frequency components shown on the screen makes it difficult to measure individual components, use the Zoom button to magnify the FFT waveform.
- Use a filter on the source signal to bandwidth limit the signal to frequencies below that of the Nyquist frequency. If the frequency components you want to view are below the built-in bandwidth settings (20 MHz bandwidth for all oscilloscopes, 150 MHz bandwidth for 300 MHz and 500 MHz oscilloscopes), set the source channel bandwidth to the appropriate value. Push the Vertical MENU button to access the channel bandwidth menu.

# Reference

The FFT process mathematically converts a time-domain signal into its frequency components. You can set the following FFT measurement parameters:

- The input source
- The FFT window function
- The vertical scale

## FFT Menu

The following table and text describes the Math FFT bottom and side menu items.

### Math Menu

Bottom	Side	Description
FFT	Set FFT Source to	Sets the FFT signal source. Valid input sources are Ch 1 and Ch 2 (two-channel instruments), Ch 1 through Ch 4 (four-channel instruments), and Ref 1 through Ref 4 (all instruments).
	Set FFT Vert Scale to	Sets the display vertical scale units. Available scales are dBV RMS and Linear RMS.
	Set FFT Window to	Sets which window function (Hanning, Hamming, Blackman-Harris, or Rectangular) to apply to the source signal.

### FFT Source Key Points

- Push the side menu button to select the signal source.
- Using FFT slows down the oscilloscope's response time in Normal acquisition mode (10k record length).
- A waveform acquired in Normal acquisition mode has a lower noise floor and better frequency resolution than a waveform acquired in Fast Trigger mode.
- Signals that have a DC component or offset can cause incorrect FFT waveform component magnitude values. To minimize the DC component, choose AC Coupling.
- To reduce random noise and aliased components in repetitive or single-shot events, set the oscilloscope acquisition mode to average over 16 or more samples. Average mode attenuates signals not synchronized with the trigger.
- Do not use the Average acquisition mode if the source signal contains frequencies of interest that are not synchronized with the trigger rate.
- Do not use Peak Detect and Envelope modes with FFT. Peak Detect and Envelope modes can add significant distortion to the FFT results.
- For transient (impulse, one-shot) signals, set the oscilloscope to trigger on the transient pulse in order to center the pulse information in the waveform record.

### **FFT Vertical Scale Key Points**

- Push the side menu button to select a scale.
- Use the Vertical POSITION and SCALE knobs to vertically move and rescale the FFT waveform.
- To display FFT waveforms with a large dynamic range, use the dBV RMS scale. The dBV RMS scale displays component magnitudes using a log scale, expressed in dB relative to  $1 V_{RMS}$ , where  $0 \text{ dB} = 1 V_{RMS}$ , or in source waveform units (such as amps for current measurements).
- To display FFT waveforms with a small dynamic range, use the Linear RMS scale. The Linear RMS scale lets you display and directly compare components with similar magnitude values.

### **FFT Window Key Points**

- Push the side menu button to select a window.
- Available windows are Hanning, Hamming, Blackman-Harris, and Rectangular. Refer to page 13 for information on window characteristics and selecting a window.

### **Nyquist Frequency Key Point**

- To determine the Nyquist frequency, push the ACQUIRE menu button. This displays the current sample rate on the bottom right area of the screen. The Nyquist frequency is one-half of the sample rate. For example, if the sample rate is 25.0 MS/s, then the Nyquist frequency is 12.5 MHz.

## Zooming an FFT Waveform

Use the Zoom button along with horizontal POSITION and SCALE controls to magnify FFT waveforms. When you change the zoom factor, the FFT waveform is horizontally magnified about the center vertical graticule line. The FFT waveform is vertically magnified about the M marker (the math waveform reference point icon on the left edge of the display). Zoom does not affect the oscilloscope time base or trigger position settings.

---

**NOTE.** FFT waveforms are calculated using the entire source signal waveform record. Zooming in on a region of either the source signal or FFT waveform will not recalculate the FFT waveform for that region.

---

## Measuring FFT Waveforms Using Cursors

You can use cursors to take two measurements on FFT waveforms: magnitude (in dB, or the vertical units of the source waveform such as amps) and frequency (in Hz). dB magnitude is referenced to 0 dB, where 0 dB equals 1  $V_{RMS}$ . Use horizontal cursors (H Bars) to measure magnitude and vertical cursors (V Bars) to measure frequency.

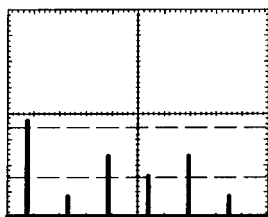

Magnitude cursors (H bars)

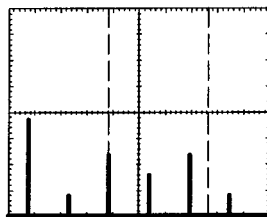

Frequency cursors (V bars)

## FFT Example 1

A pure sine wave can be input into an amplifier to measure distortion; any amplifier distortion will introduce harmonics in the amplifier output. Viewing the FFT of the output can determine if low-level distortion is present.

You are using a 10 MHz signal as the amplifier test signal. You would set the oscilloscope and FFT parameters as listed in the table:

<b>Control</b>	<b>Setting</b>
CH 1 Coupling	AC
Acquisition Mode	Average 16
Horizontal Resolution	Normal (10k points)
Horizontal SCALE	2.00 $\mu$ s
FFT Source	Ch 1
FFT Vert Scale	dBV
FFT Window	Blackman-Harris

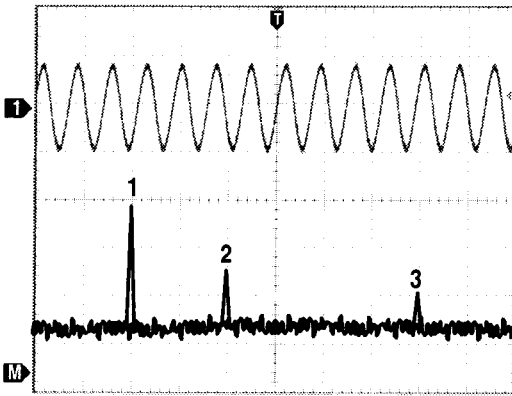

The first component at 20 MHz (figure label 1) is the source signal fundamental frequency. The FFT waveform also shows a second-order harmonic at 40 MHz (2) and a fourth-order harmonic at 80 MHz (3). The presence of components 2 and 3 indicate that the system is distorting the signal. The even harmonics suggest a possible difference in signal gain on half of the signal cycle.

## FFT Example 2

Noise in mixed digital/analog circuits can be easily observed with an oscilloscope. However, identifying the sources of the observed noise can be difficult, if not impossible.

The FFT waveform displays the frequency content of the noise; you may then be able to associate those frequencies with known system frequencies, such as system clocks, oscillators, read/write strobes, display signals, switching power supplies, and so on.

The highest frequency on the example system is 40 MHz. You would set the oscilloscope and FFT parameters as listed in the table:

<b>Control</b>	<b>Setting</b>
CH 1 Coupling	AC
Acquisition Mode	Sample
Horizontal Resolution	Normal (10k points)
Horizontal SCALE	4.00 $\mu$ s
FFT Source	Ch 1
FFT Vert Scale	dBV
FFT Window	Hanning



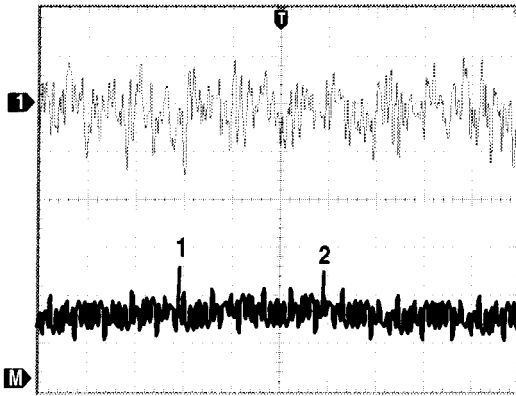

Note the component at 31 MHz (figure label 1); this coincides with a 31 MHz memory strobe signal in the example system. There is also a frequency component at 62 MHz (figure label 2), which is the second harmonic of the strobe signal.



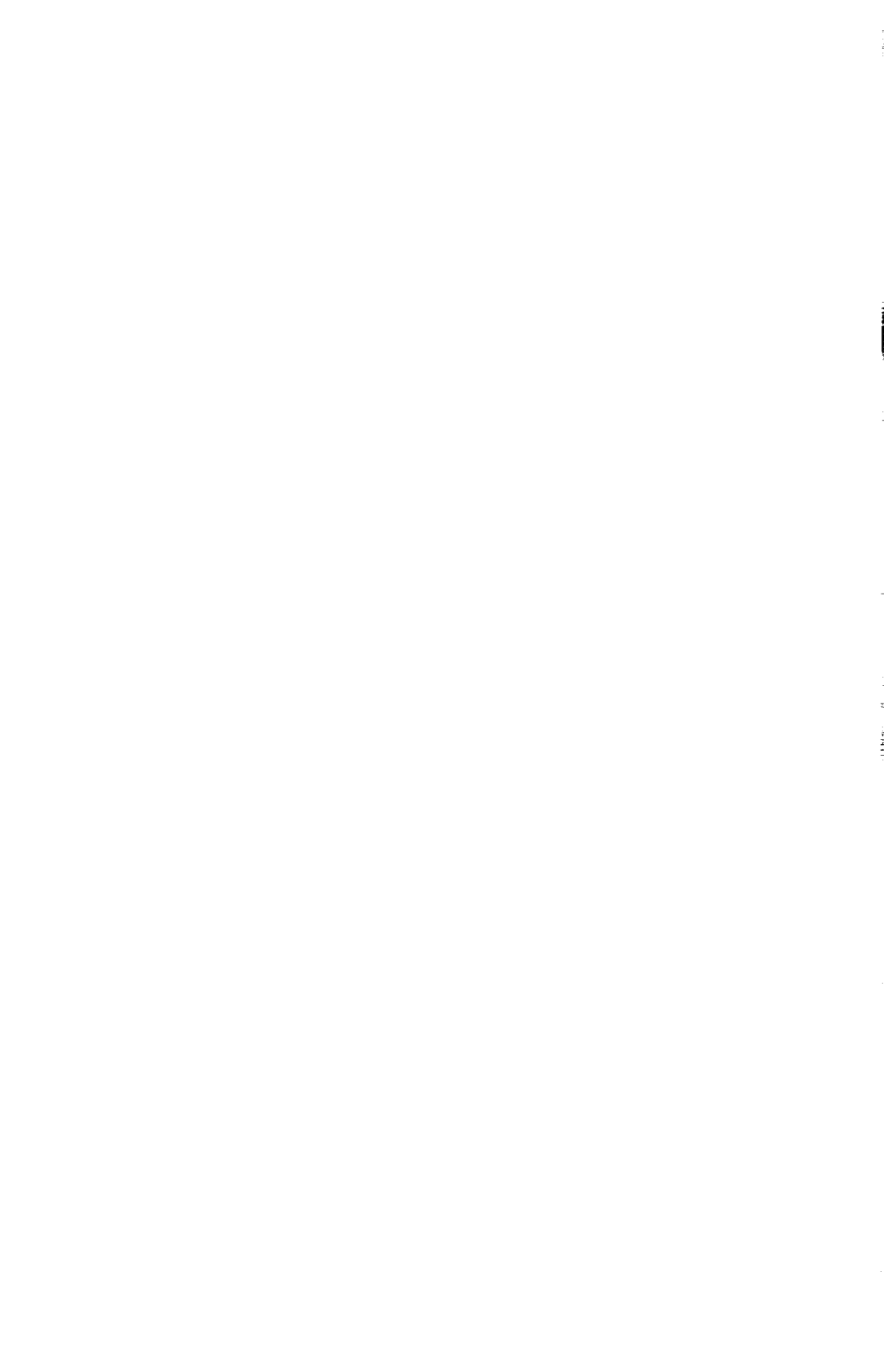



Printed on recyclable paper. Please recycle.

# User Manual

**Tektronix**



## **TDS3VID Extended Video Application Module**

**071-0305-01**



071030501



# **User Manual**

**Tektronix**

**TDS3VID**  
**Extended Video Application Module**  
**071-0305-01**

This document supports firmware version 2.00  
and above.



Copyright © Tektronix, Inc. All rights reserved.

Tektronix products are covered by U.S. and foreign patents, issued and pending. Information in this publication supercedes that in all previously published material. Specifications and price change privileges reserved.

Printed in the U.S.A.

Tektronix, Inc., P.O. Box 1000, Wilsonville, OR 97070-1000

TEKTRONIX and TEK are registered trademarks of Tektronix, Inc.

DPX is a trademark of Tektronix, Inc.



## **WARRANTY SUMMARY**

Tektronix warrants that the products that it manufactures and sells will be free from defects in materials and workmanship for a period of three (3) years from the date of shipment from an authorized Tektronix distributor. If a product proves defective within the respective period, Tektronix will provide repair or replacement as described in the complete warranty statement.

To arrange for service or obtain a copy of the complete warranty statement, please contact your nearest Tektronix sales and service office.

**EXCEPT AS PROVIDED IN THIS SUMMARY OR THE APPLICABLE WARRANTY STATEMENT, TEKTRONIX MAKES NO WARRANTY OF ANY KIND, EXPRESS OR IMPLIED, INCLUDING WITHOUT LIMITATION THE IMPLIED WARRANTIES OF MERCHANTABILITY AND FITNESS FOR A PARTICULAR PURPOSE. IN NO EVENT SHALL TEKTRONIX BE LIABLE FOR INDIRECT, SPECIAL OR CONSEQUENTIAL DAMAGES.**





# Table of Contents

General Safety Summary .....	iii
Preface .....	v
Contacting Tektronix .....	vi

## Getting Started

Installing Application Module and Firmware .....	1
Checking Module Installation .....	4
Troubleshooting Module Installation .....	5

## Operating Basics

Extended Video Features .....	6
Accessing Extended Video Functions .....	8

## Reference

Extended Video Conventions .....	10
Changes to the Video Trigger Menu .....	11
Changes to the Display Graticule Menu .....	14
Changes to the Acquire Menu .....	15
Video QuickMenu (New) .....	15
Video Example 1 (Autoset) .....	19
Video Example 2 (Trigger On Line) .....	20
Video Example 3 (Custom Video) .....	21
Video Example 4 (Holdoff Fields) .....	22

## Table of Contents

---

# General Safety Summary

Review the following safety precautions to avoid injury and prevent damage to this product or any products connected to it. To avoid potential hazards, use this product only as specified.

*Only qualified personnel should perform service procedures.*

While using this product, you may need to access other parts of the system. Read the *General Safety Summary* in other system manuals for warnings and cautions related to operating the system.

## To Avoid Fire or Personal Injury

**Do Not Operate With Suspected Failures.** If you suspect there is damage to this product, have it inspected by qualified service personnel.

**Do Not Operate in Wet/Damp Conditions.**

**Do Not Operate in an Explosive Atmosphere.**

## Safety Terms and Symbols

**Terms in This Manual.** The following term appears in this manual:



---

**CAUTION.** *Caution statements identify conditions or practices that could result in damage to this product or other property.*

---

## Preventing Electrostatic Damage



---

**CAUTION.** *Electrostatic discharge (ESD) can damage components in the oscilloscope and its accessories. To prevent ESD, observe these precautions when directed to do so.*

---

**Use a Ground Strap.** Wear a grounded antistatic wrist strap to discharge the static voltage from your body while installing or removing sensitive components.

**Use a Safe Work Area.** Do not use any devices capable of generating or holding a static charge in the work area where you install or remove sensitive components. Avoid handling sensitive components in areas that have a floor or benchtop surface capable of generating a static charge.

**Handle Components Carefully.** Do not slide sensitive components over any surface. Do not touch exposed connector pins. Handle sensitive components as little as possible.

**Transport and Store Carefully.** Transport and store sensitive components in a static-protected bag or container.



# Preface

The TDS3VID Extended Video application module provides new video-related functions to the TDS3000 series Digital Phosphor Oscilloscope. These new functions make it easier to capture, display, and measure video waveforms from both broadcast- and non-broadcast equipment.

This User Manual describes the capabilities, operation, and applications of the Extended Video application module. The following table shows where to find information in this manual.

<b>If you are looking for:</b>	<b>Turn to:</b>
Installation information	<i>Installing Application Module and Firmware</i> on page 1
Product overview	<i>Extended Video Features</i> on page 6
Basic operating instructions	<i>Accessing Extended Video Functions</i> on page 8
Function details	<i>Reference</i> section starting on page 10

## Contacting Tektronix

**Product Support** For questions about using Tektronix measurement products, call toll free in North America:  
1-800-TEK-WIDE (1-800-835-9433 ext. 2400)  
6:00 a.m. – 5:00 p.m. Pacific time

Or contact us by e-mail:  
tm\_app\_supp@tektronix.com

For product support outside of North America, contact your local Tektronix distributor or sales office.

**Service Support** Tektronix offers extended warranty and calibration programs as options on many products. Contact your local Tektronix distributor or sales office.

For a listing of worldwide service centers, visit our web site.

**For other information** In North America:  
1-800-TEK-WIDE (1-800-835-9433)  
An operator will direct your call.

**To write us** Tektronix, Inc.  
P.O. Box 1000  
Wilsonville, OR 97070-1000  
USA

**Website** Tektronix.com



# Getting Started

This chapter describes how to install and check the TDS3VID Extended Video application module.

## Installing Application Module and Firmware

You can install up to four application modules in the oscilloscope. Application modules go into the two slots with windows in the upper right corner of the front panel. Two additional slots are located behind the two front slots.

---

**NOTE.** *You do not need to do the following procedure if you purchased a four-channel oscilloscope with pre-installed application modules.*

*You must do the firmware install procedure the first time you install a new application module.*

*You do not need to reinstall the firmware if you remove and reinstall an application module.*

---



---

**CAUTION.** *To avoid damage to the oscilloscope or application module, observe the ESD precautions described on page iv.*

---

To install an application module and its associated oscilloscope firmware, do these steps:

1. Save any oscilloscope settings and/or reference waveforms to floppy disk before doing these steps.
2. Turn the oscilloscope power off.
3. Open the small door in the upper right corner of the front panel.
4. Slide the application module into any available slot with the module contacts facing the circuit board. Use a small screwdriver to remove an existing module if it is necessary to make space for a new application module.
5. Close the module door.

---

**NOTE.** *If you remove an application module, the features provided by that application module are no longer available. You can reinstall the module to restore the features.*

---

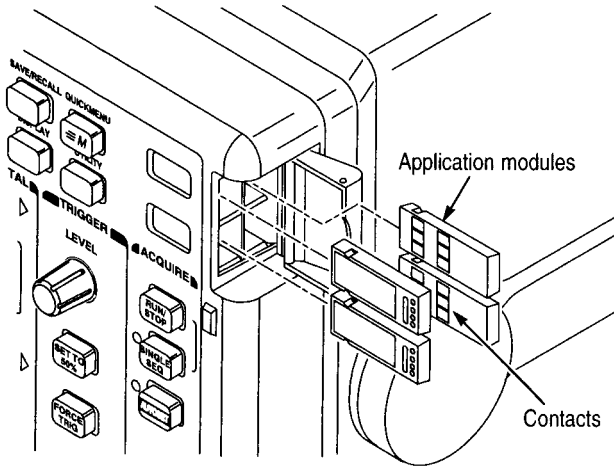

6. If the application module came with one or more floppy disks, insert the firmware upgrade floppy disk into the floppy disk drive. If there is more than one floppy disk, insert firmware upgrade floppy disk number one into the floppy disk drive.
7. Power on the oscilloscope. The oscilloscope determines whether the firmware update is necessary. If no firmware update is necessary, the oscilloscope displays the following message:

“A floppy disk has been detected which contains instrument firmware. However, the firmware on the disk is not newer than the instrument firmware.

Push **MENU OFF** to remove this message”

Push the **MENU OFF** button and then go to step 10.

If a firmware update is necessary, the oscilloscope displays the following message:

“This procedure will replace the firmware in the instrument with firmware from the floppy disk. Do not turn the instrument off or eject the floppy disk until the procedure is complete. This procedure will take approximately 7 minutes.

Push ‘OK Load New Firmware’ to proceed.”

8. Push **OK Load New Firmware** to begin loading the firmware. The oscilloscope shows a clock icon on the screen while the firmware upgrade is in process. If a second firmware floppy disk is required, the oscilloscope will instruct you to eject the first disk and insert the second disk.

When the firmware upgrade is complete, the oscilloscope will restart automatically with the new firmware.

---

**NOTE.** *If you power off the oscilloscope, eject the floppy disk, or there is a power outage during the firmware upgrade process, you must power off the oscilloscope and repeat the firmware upgrade procedure, starting at step 6, before you can use the oscilloscope.*

---

9. If you do not want to upgrade the firmware, push **MENU OFF**.

---

**NOTE.** *If you do not update the oscilloscope firmware, the new application module may not function at all, or may not function correctly. It is strongly recommended that you install new firmware.*

---

10. Do not forget to remove the floppy disk when you are done with the firmware upgrade.

You are done installing the application module and firmware.

## Checking Module Installation

Do these steps to check that the TDS3VID Extended Video application module is correctly installed. If the oscilloscope does not show the application module menu items, do the steps in *Troubleshooting Module Installation*.

1. Power on the oscilloscope. Look at the oscilloscope startup screen; it should list the newly-installed module. If the oscilloscope displays a message stating that you need to upgrade firmware, power off the oscilloscope and do the steps in the *Firmware Upgrade Procedure*, starting at step 6 on page 3.
2. Push the **QUICKMENU** panel button.
3. Push the **Menu** bottom button to cycle through the available QuickMenu items. The menu should include the **Video** menu item.

If the oscilloscope does not show the application module menu item, do the steps in *Troubleshooting Module Installation*.

## Troubleshooting Module Installation

If the oscilloscope does not recognize the application module at power-up, do these steps:

1. Turn off the oscilloscope.
2. Follow the ESD precautions listed on page iv.
3. Remove the application module (refer to step 4 on page 2).
4. Examine the oscilloscope and application module contacts for damage.
5. Reinsert the application module into the oscilloscope.
6. Turn on the oscilloscope. If the oscilloscope does not display the application menu items as listed in *Checking Module Installation*, power off the oscilloscope and reinstall the application module into a different slot.
7. Turn on the oscilloscope. If the oscilloscope now shows the application module menu items, you have a problem with one of the application module slots. Contact the nearest Tektronix service center to resolve the problem.

If the oscilloscope does not show the application menu items, power off the oscilloscope and reinstall the oscilloscope firmware by starting at step 6 on page 3 (*Installing Application Module and Firmware*).

8. If, after reinstalling the firmware, the oscilloscope still does not show the application module menu items, contact the nearest Tektronix service center.



# Operating Basics

This chapter describes the features of the Extended Video application module and how to access the extended video functions.

## Extended Video Features

The Extended Video application module adds new video functions to your TDS3000 series oscilloscope. This section provides an overview of these new features.

### Video QuickMenu

Use the video QuickMenu function to display a bottom and side menu that contains video functions useful for displaying and measuring broadcast-standard (NTSC, PAL, and SECAM) waveforms, including trigger source, when to trigger, video graticule, and video Autoset.

### Video Autoset

Use the autoset function to automatically adjust the vertical, horizontal, and video trigger settings to display a video waveform triggered on all lines or fields. You can then manually adjust controls to optimize the display. This function is available in the video QuickMenu and in the Acquire menu.

### Custom Video

Use the custom video function to specify custom horizontal scan rates in order to trigger on non-broadcast video waveforms, such as those used by computer monitors and medical equipment displays.

**Trigger On Specific Lines (Line Select)**

Use the trigger on lines function to trigger the oscilloscope on specific lines in 525/NTSC, 625/PAL, and SECAM-standard video waveforms, as well as for non-broadcast (custom) video waveforms.

**Field Holdoff**

Use the field holdoff function to specify a number of fields to wait before re-enabling triggering. This lets the oscilloscope always trigger on a single field (for example, field 1 or field 3 of NTSC) instead of on both field 1 and field 3.

**Video Graticules**

Use the video graticule functions to change the standard oscilloscope graticule to either IRE (for 525/NTSC signals) or mV (for PAL/SECAM or component signals). Video graticules make it easier for you to measure and analyze video waveforms.

Selecting a video graticule automatically sets the vertical scale to 143 mV/div. The video graticules include labeled marks for doing component signal measurement.

---

**NOTE.** Changing from the IRE or mV graticule to any other graticule style does not reset the volts/division scale from 143 mV. Use the Vertical SCALE knob to change the volts/division setting.

*Hbar cursor readouts are in IRE units when the IRE graticule is active.*

---

## Accessing Extended Video Functions

The following text describes how to access the new extended video functions in the menu system.

### Video QuickMenu

To display the video QuickMenu, push the QUICKMENU panel button, then the Menu bottom button to select and display the video QuickMenu.

### Video Triggering

To set the extended video trigger functions, push the Trigger MENU button, then the Type bottom screen button, to display and select Video triggering. The extended video functions are added to the standard video trigger menus.

### Video Autoset

Video Autoset automatically sets up the oscilloscope to trigger and display a video waveform. You can run video Autoset from the Acquire menu or the QuickMenu.

---

**NOTE.** *Video Autoset is only available through the ACQUIRE or QuickMenu menus. The AUTOSET front-panel button always runs the standard oscilloscope edge-trigger autoset function.*

---

**ACQUIRE Menu.** To execute the video autoset function from the ACQUIRE menu, do these steps:

1. Push the Acquire **MENU** button to display the Acquire menu.
2. Push the **Autoset** bottom menu button to display the Autoset side menu.
3. Push the **Video Autoset** side menu button to automatically display a video waveform triggered on all lines.



**QUICKMENU.** To execute the video autosest function from the video QuickMenu, do these steps:

1. Push the **QUICKMENU** button to display the QuickMenu menu.
2. Push the **MENU** bottom button to select and display the video QuickMenu items.
3. Push the **AUTOSET** bottom button to automatically display a video waveform triggered on all lines.

### **Video Graticules (IRE/mV)**

To change the screen graticule to IRE or mV format, do either of the following:

- Push the **DISPLAY** button, then the **Graticule** bottom button to display the graticule side menu. Push the **–more–** button to display the IRE and mV buttons if they are not already displayed.
- Display the video QuickMenu (described above), which lets you select IRE, mV, or normal (Full) graticule formats from the **GRATICULE** bottom button.



## Reference

The Extended Video application module affects the functions of several oscilloscope menus. The following sections describe these changes in more detail.

### Extended Video Conventions

The following conventions apply to one or more of the extended video functions:

- You can still use the other menus after using the video QuickMenu. For example, if you push the MEASURE button, you can set up and take waveform measurements in the usual way. To return to the video QuickMenu, push the QUICKMENU button.
- You cannot use video triggering to arm B triggering.
- The oscilloscope does not have video signal clamping. Tektronix offers an optional Video Display Clamp module (part number 013-0278-00) that provides video signal clamping.

## Changes to the Video Trigger Menu

The extended video application module adds the following functions to the Standard video trigger pop-up menu:

Standard pop-up menu item	Bottom menu item	New/changed side menu item(s)
525/NTSC, 625/PAL, and SECAM	Trigger On	Line Number. Refer to page 11 for a description.
	Mode & Holdoff	Holdoff (Fields). Refer to page 11 for a description.
Custom (new pop-up menu choice)	Scan Rate (new bottom menu button)	Refer to page 13 for a description

### Key Points

**Trigger On Line Number.** Sets the specific video field and line number on which to trigger. Use the general purpose knob to change values.

For 525/NTSC, the range of values is 1 through 263 for odd fields, and 1 through 262 for even fields. Increasing the line count when at odd field line 263 changes the setting to even field line 1.

For 625/PAL and SECAM, the range of line values is 1 through 625. Increasing the line count when at line 625 changes the setting to line 1.

**Holdoff (Fields).** This function lets you specify a number of fields to wait before re-arming the video trigger. For example, when you select to trigger on odd fields, the oscilloscope triggers on all odd-numbered fields (1 and 3 for NTSC signals; 1, 3, 5, and 7 for PAL/SECAM signals). Selecting even-field triggering causes the oscilloscope to trigger on all even-numbered fields.

Default: trigger on an odd field triggers on all odd fields (example NTSC signal).

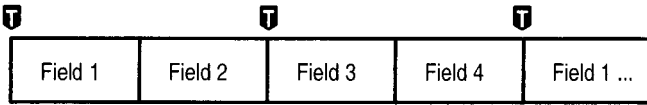

T = Trigger points

You use the Holdoff Field function to trigger the oscilloscope on the same field. The holdoff process begins when the oscilloscope recognizes a video trigger event. The oscilloscope acquires the signal and disables the trigger system until the specified number of fields have passed. The oscilloscope then re-arms the video trigger system and waits for the next valid video trigger. This enables the oscilloscope to always trigger on the same field.

Holdoff Field: holding off 2.5 fields triggers on the same odd field (example NTSC signal).

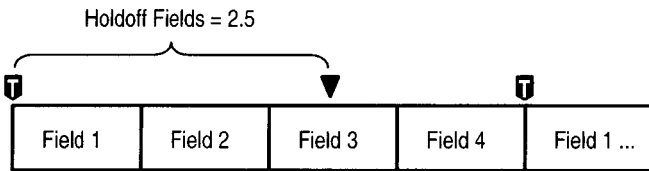

T = trigger points ▼ = Video trigger armed Triggers are not recognized during holdoff

Although Holdoff Field triggering enables you to trigger on the same field, it does not let you specify the exact field on which to trigger. Use the SINGLE SEQ button to retrigger the oscilloscope on a particular field.

**Custom.** The Custom video menu adds a new Scan Rate bottom button that displays a side menu for selecting horizontal scan rate ranges. Custom scan rates lets you view nonbroadcast video waveforms such as those used by display monitors in the security, computer, and medical equipment industry.

**Trigger Menu: Type = Video, Standard = Custom**

Bottom	Side	Description
Scan Rate	Rate 1 15-20 kHz (Broadcast)	Sets the video trigger hardware to search for negative sync pulses within the specified video scan rate range.
	Rate 2 20-25 kHz	
	Rate 3 25-35 kHz	
	Rate 4 35-50 kHz	
	Rate 5 50-65 kHz	

**NOTE.** While you are in custom video mode, the Trigger On Line Number function's range of values is 1 to 3000.

The oscilloscope will display video waveforms for signals with scan rates greater than 65 kHz. However, the waveform data (such as line count) may not be accurate because the oscilloscope is triggering on the next-detected sync pulse. The oscilloscope may miss some sync pulses when scan rates are greater than 65 kHz.

## Changes to the Display Graticule Menu

The extended video application module adds the following settings to the DISPLAY Graticule menu.

Bottom	Side	Description
Graticule	IRE	Displays an IRE measurement graticule ranging from -40 to +120 IRE, in 10 IRE units (1 IRE = 7.14 mV). Selecting the IRE graticule sets the vertical scale to 143 mV/div.
	mV	Displays an PAL measurement graticule ranging from -30 mV to +80 mV. Selecting the mV graticule sets the channel vertical scale to 143 mV/div.

### Key Points

**Component Signals.** Both graticules include labeled graticule marks that are useful for measuring component signals.

**IRE Measurements and Cursors.** Hbar-cursor values are shown in IRE units when the IRE graticule is active.

---

**NOTE.** Changing from the IRE or mV graticule to any other graticule style does not reset the volts/division scale from 143 mV. Use the Vertical SCALE knob to change the volts/division setting.

*Hbar cursor readouts are in IRE units when the IRE graticule is active.*

---

## Changes to the Acquire Menu

The extended video application module adds the following new side menu item to the Acquire Autoset menu.

Side menu	Description
Video Autoset	Executes the video autoset function to automatically display a video waveform triggered on all lines.

## Video QuickMenu (New)

The Extended Video application module provides a QuickMenu for video functions. Video QuickMenu provides a bottom and side menu containing key video-related functions to quickly let you acquire, display, and measure video signals. The following tables describe the video QuickMenu bottom and side menu items.

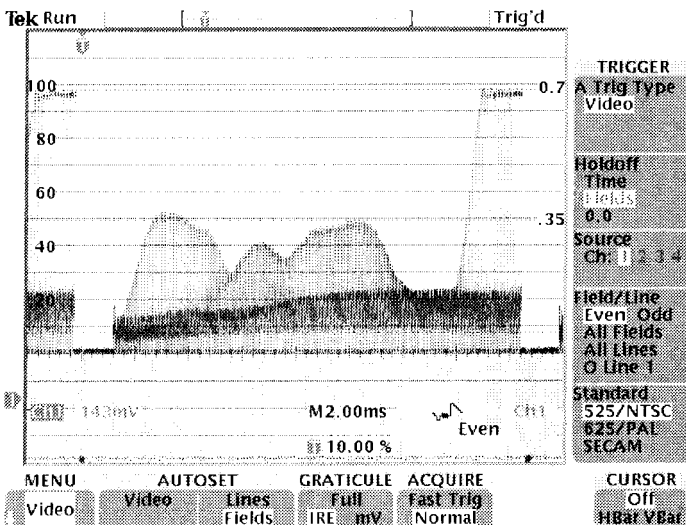

Bottom menu	Value	Description
MENU	Scope, Video	Displays available QuickMenus. Select Video to display the video QuickMenu.
AUTOSET	Video	Automatically adjusts the vertical, horizontal, and video trigger settings to display a video waveform triggered on all lines. It also displays a video graticule and sets the vertical scale to 143 mV/division.
	Lines	Sets the time base to 10.0 $\mu$ s/div and the trigger mode to trigger on all lines.
	Fields	Sets the time base to 2.00 ms/div and the trigger mode to trigger on all fields. Autoset Fields is only available in the video QuickMenu.
GRATICULE	Full	Displays the full oscilloscope graticule.
	IRE	Displays an IRE video graticule and sets the vertical scale to 143 mV/div.
	mV	Displays a mV video graticule and sets the vertical scale to 143 mV/div.
ACQUIRE	Fast Trig	Sets the acquisition mode to Fast Trigger (500 points).
	Normal	Sets the acquisition mode to Normal (10K points).
CURSOR	Off	Turns cursors off.
	HBar	Displays horizontal measurement cursors. If the IRE graticule is on, HBar readouts are displayed in IRE units.
	VBar	Displays vertical measurement cursors.



Side menu (TRIGGER)	Setting	Description
A Trig Type	Video	Displays whether video triggering is enabled. Video is the only field in this side menu item. Push the side button to enable (highlight) or disable video triggering.
Holdoff	Time	Sets the trigger holdoff time value. Use the general purpose knob to change the holdoff time value.
	Fields	Sets the trigger holdoff fields value. Use the general purpose knob to change the holdoff fields value, from 0 to 8.5 fields, in increments of 0.5.
Source	Ch 1, Ch 2, Ch 3, Ch 4	Sets which input to use for triggering the oscilloscope. To trigger from EXT or EXT/10, use the regular Video trigger menu.
Field/Line	Odd	Sets the oscilloscope to trigger on all odd video fields.
	Even	Sets the oscilloscope to trigger on all even video fields.
	All Fields	Sets the oscilloscope to trigger on all fields. This function is different than the AUTOSET Fields function in that All Fields does not change the oscilloscope time base.
	All Lines	Sets the oscilloscope to trigger on all lines. This function is different than the AUTOSET Lines function in that All Lines does not change the oscilloscope time base.
	O Line <i>n</i> , E Line <i>n</i> , Line <i>n</i>	Sets the oscilloscope to trigger on a specific video field ( <b>O</b> dd or <b>E</b> ven for 525/NTSC) and/or line number ( <i>n</i> ). Use the general purpose knob to change the line value.

Side menu (TRIGGER)	Setting	Description
Standard	525/NTSC	Sets the oscilloscope to trigger on 525/NTSC-standard broadcast video waveforms.
	625/PAL	Sets the oscilloscope to trigger on 625/PAL-standard broadcast video waveforms.
	SECAM	Sets the oscilloscope to trigger on SECAM-standard broadcast video waveforms.

### Key Points

**Autoset Settings.** The video Autoset function sets the oscilloscope as follows:

Oscilloscope setting	Value
Trigger	AUTOSET Lines: Video trigger, All Lines AUTOSET Fields: Video trigger, All Fields
Vertical scale	143 mV/div
Vertical position	-2 divisions
Horizontal time	AUTOSET Lines: 10.0 $\mu$ s/div AUTOSET Fields: 2.00 ms/div
Trigger position	10%
Acquisition mode	AUTOSET Lines: Fast Trigger (500 pts.) AUTOSET Fields: Normal (10k pts.)
Delay mode	Off
Bandwidth	Full

**Component Signals.** Both graticules include marks that are useful for measuring component signals.

**AUTOSET Lines/Fields and Trigger All Lines/All Fields.** The AUTOSET Lines/Fields functions (video QuickMenu bottom menu) differ from the All Fields/All Lines side menu functions in that the AUTOSET Lines/Fields functions change the video trigger type and the oscilloscope time base. The All Fields/All Lines side menu only changes the video trigger type.

## Video Example 1 (Autoset)

In this example, you are trying to troubleshoot where a broadcast video signal is getting lost at a master control feed. You need to quickly acquire a waveform at different test points. Do these steps:

1. Connect the oscilloscope to the video signal using proper adapters and the 75 ohm terminator if necessary.
2. Push the Acquire **MENU** button.
3. Push the **Autoset** bottom button.
4. Push the **Video Autoset** side button. If a broadcast-standard video waveform is present, the oscilloscope displays a stable video waveform that is triggered on all lines.
5. Connect the oscilloscope to the other test points until you locate where the signal is lost. You do not need to change any oscilloscope settings.

## Video Example 2 (Trigger On Line)

In this example, you suspect that one or more pixels are defective in a Charge-Coupled Device (CCD) video camera. You need to determine which line in which fields contain the defective pixel(s). Do these steps:

1. Connect the video camera output signal to the oscilloscope using proper adapters and the 75 ohm terminator if necessary.
2. Cover the camera lens with a lens cover so that no light enters the lens.
3. Push the **QUICKMENU** button to display the QuickMenu.
4. If the video QuickMenu is not displayed, push the **MENU** bottom button to display the video QuickMenu.
5. Push the **AUTOSET Video** bottom button to automatically display a video waveform that triggers on all lines.
6. Push the **ACQUIRE** bottom button to select **Normal**; this increases the waveform resolution.
7. Push the **Field/Line** side button to select **O Line n** or **E Line n** (525/NTSC), or **Line n** (625/PAL and SECAM). This menu item lets you use the general purpose knob to display the video signal at each line.
8. Rotate the general purpose knob to examine each video line. Write down the line number (and field if applicable) of any pixels that exceed error specifications. You can also use the Zoom function to magnify the line display and determine the number of defective pixels in a line.

## Video Example 3 (Custom Video)

In this example, you need to display a video waveform from a computer display driver. Do these steps to display the waveform:

1. Connect the video signals to the oscilloscope using proper adapters and the 75 ohm terminator if necessary.
2. Push the Trigger **MENU** button.
3. Push the **Type** bottom button to select **Video**.
4. Push the **Standard** bottom button to select **Custom**.
5. Push the **Source** bottom button to display the A Trigger Source side menu.
6. Push the appropriate side menu button to select the trigger source channel that contains the video sync signal.
7. Push the **Trigger On** bottom button and side menu to set the video trigger condition.
8. Push the **Scan Rate** bottom button to display the scan rate side menu.
9. Push the appropriate Scan Rate side button to select the horizontal scan rate of the waveform for your video system.  
The oscilloscope displays the video waveform.

---

**NOTE.** *The oscilloscope will display video waveforms for signals with scan rates greater than 65 kHz. However, the waveform data (such as line count) may not be accurate because the oscilloscope is triggering on the next-detected sync pulse. The oscilloscope may miss some sync pulses when scan rates are greater than 65 kHz.*

---

## Video Example 4 (Holdoff Fields)

In this example, you are examining a 525/NTSC video waveform. You need to examine the colorburst signal of field 1 without mixing it with the out-of-phase colorburst signal of field 3. Do these steps:

1. Connect the oscilloscope to the video signal using proper adapters and the 75 ohm terminator if necessary.
2. Push the **QUICKMENU** button to display the QuickMenu.
3. If the video QuickMenu is not displayed, push the **MENU** bottom button to display the video QuickMenu.
4. Push the **Standard** side button to select the video standard.
5. Push the **AUTOSET Video** bottom button to automatically display a video waveform that triggers on all lines.
6. Set the horizontal scale to 1.00  $\mu$ s.
7. Use the **HORIZONTAL POSITION** knob to position the colorburst signal toward the center of the screen.
8. Push the **Field/Line** side button to select **O Line  $n$** , where  $n$  represents the current value of the line argument.
9. Rotate the general purpose knob to set the line number to the first colorburst line, which for NTSC signals is line ten.
10. Push the **Holdoff** side button to select **Fields**. This menu lets you specify the number of video fields to skip before re-arming the video trigger.
11. Rotate the general purpose knob to set the number of holdoff fields to 2.5.

12. Determine which field you are triggering on. If necessary, use the Zoom button to magnify the colorburst signal.

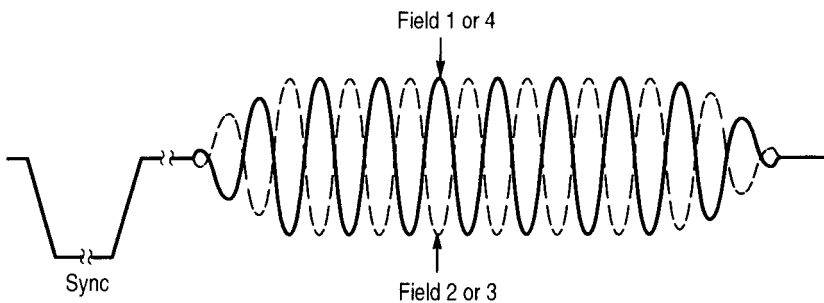

13. If the oscilloscope is triggering on field 2, repeatedly push the **SINGLE SEQ** button until the colorburst waveform changes to the correct phase for field 1, and then push the **RUN/STOP** button to resume triggering the oscilloscope.





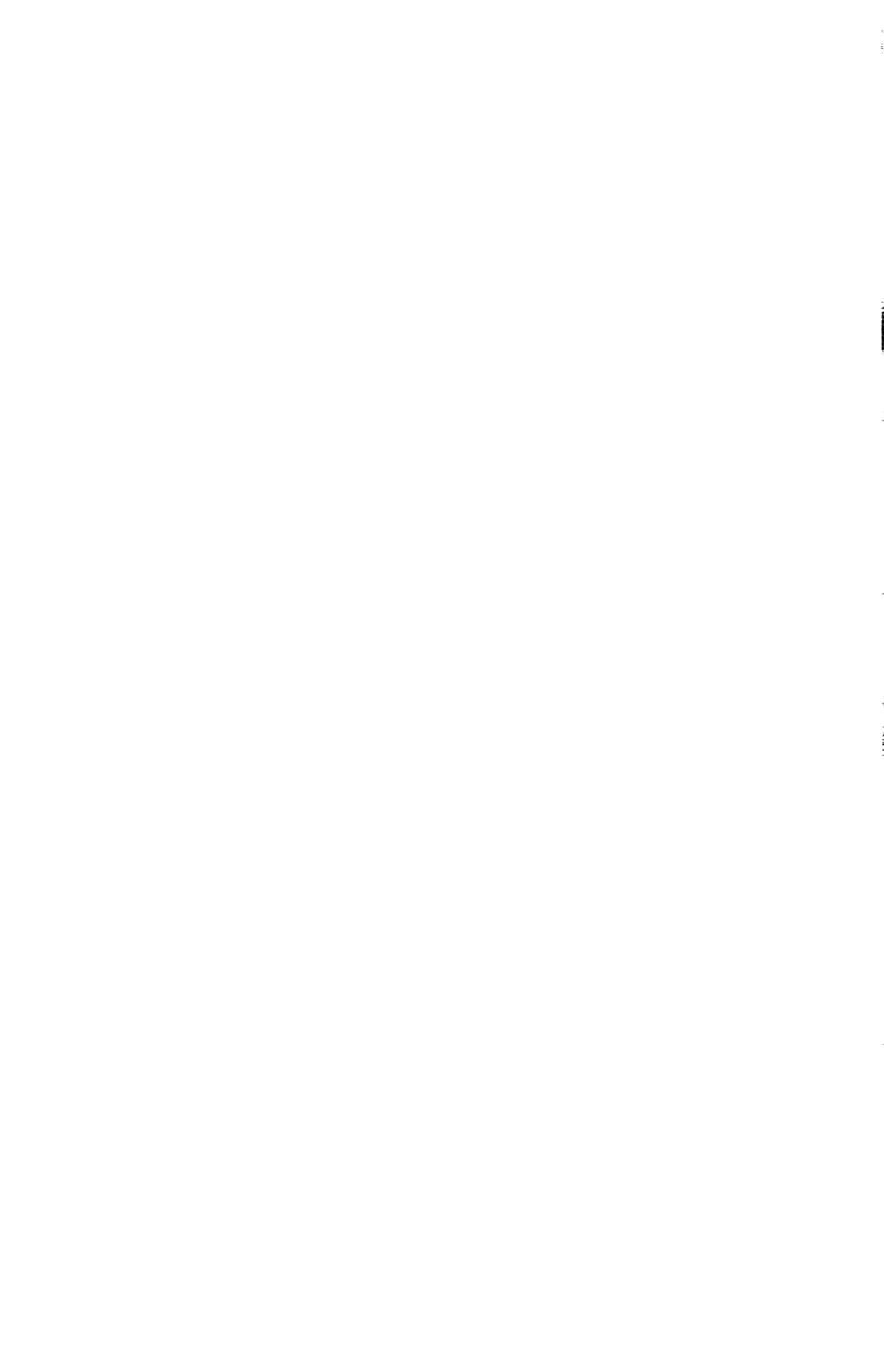



Printed on recyclable paper. Please recycle.

# User Manual

**Tektronix**



## **TDS3TMT Telecom Mask Test Application Module**

**071-0305-01**



071030501



# **User Manual**



## **TDS3TMT Telecom Mask Test Application Module**

**071-0305-01**

This document supports firmware version 2.00  
and above.

Copyright © Tektronix, Inc. All rights reserved.

Tektronix products are covered by U.S. and foreign patents, issued and pending. Information in this publication supercedes that in all previously published material. Specifications and price change privileges reserved.

Tektronix, Inc., P.O. Box 1000, Wilsonville, OR 97070-1000

TEKTRONIX and TEK are registered trademarks of Tektronix, Inc.

## **WARRANTY SUMMARY**

Tektronix warrants that the products that it manufactures and sells will be free from defects in materials and workmanship for a period of three (3) years from the date of shipment from an authorized Tektronix distributor. If a product proves defective within the respective period, Tektronix will provide repair or replacement as described in the complete warranty statement.

To arrange for service or obtain a copy of the complete warranty statement, please contact your nearest Tektronix sales and service office.

**EXCEPT AS PROVIDED IN THIS SUMMARY OR THE APPLICABLE WARRANTY STATEMENT, TEKTRONIX MAKES NO WARRANTY OF ANY KIND, EXPRESS OR IMPLIED, INCLUDING WITHOUT LIMITATION THE IMPLIED WARRANTIES OF MERCHANTABILITY AND FITNESS FOR A PARTICULAR PURPOSE. IN NO EVENT SHALL TEKTRONIX BE LIABLE FOR INDIRECT, SPECIAL OR CONSEQUENTIAL DAMAGES.**







# Table of Contents

<b>General Safety Summary</b> .....	<b>iii</b>
<b>Preface</b> .....	<b>v</b>
<b>Contacting Tektronix</b> .....	<b>vi</b>

## Getting Started

Installing Application Module and Firmware .....	1
Checking Module Installation .....	4
Troubleshooting Module Installation .....	5

## Operating Basics

Telecom Mask Test Features .....	6
Accessing Telecom Mask Test Functions .....	7

## Reference

Conventions .....	10
TDS3TMT Menu .....	11
Telecom Pass/Fail Mask Test Example .....	26

## Table of Contents

---

# General Safety Summary

Review the following safety precautions to avoid injury and prevent damage to this product or any products connected to it. To avoid potential hazards, use this product only as specified.

*Only qualified personnel should perform service procedures.*

While using this product, you may need to access other parts of the system. Read the *General Safety Summary* in other system manuals for warnings and cautions related to operating the system.

## To Avoid Fire or Personal Injury

**Do Not Operate With Suspected Failures.** If you suspect there is damage to this product, have it inspected by qualified service personnel.

**Do Not Operate in Wet/Damp Conditions.**

**Do Not Operate in an Explosive Atmosphere.**

## Safety Terms and Symbols

**Terms in This Manual.** The following term appears in this manual:



---

**CAUTION.** *Caution statements identify conditions or practices that could result in damage to this product or other property.*

---

## Preventing Electrostatic Damage



---

**CAUTION.** *Electrostatic discharge (ESD) can damage components in the oscilloscope and its accessories. To prevent ESD, observe these precautions when directed to do so.*

---

**Use a Ground Strap.** Wear a grounded antistatic wrist strap to discharge the static voltage from your body while installing or removing sensitive components.

**Use a Safe Work Area.** Do not use any devices capable of generating or holding a static charge in the work area where you install or remove sensitive components. Avoid handling sensitive components in areas that have a floor or benchtop surface capable of generating a static charge.

**Handle Components Carefully.** Do not slide sensitive components over any surface. Do not touch exposed connector pins. Handle sensitive components as little as possible.

**Transport and Store Carefully.** Transport and store sensitive components in a static-protected bag or container.



# Preface

This user manual describes the capabilities, operation, and applications of the TDS3TMT Telecom Mask Test application module. The following table shows you where to find information in this manual.

<b>If you are looking for:</b>	<b>Turn to:</b>
Installation information	<i>Installing Application Module and Firmware</i> on page 1
Product overview	<i>Telecom Mask Test Features</i> on page 6
Basic operating instructions	<i>Accessing Telecom Mask Test Functions</i> on page 7
Function details	<i>Reference</i> section starting on page 10

## Contacting Tektronix

Product Support	<p>For questions about using Tektronix measurement products, call toll free in North America: 1-800-TEK-WIDE (1-800-835-9433 ext. 2400) 6:00 a.m. – 5:00 p.m. Pacific time</p> <p>Or contact us by e-mail: tm_app_supp@tektronix.com</p> <p>For product support outside of North America, contact your local Tektronix distributor or sales office.</p>
Service Support	<p>Tektronix offers extended warranty and calibration programs as options on many products. Contact your local Tektronix distributor or sales office.</p> <p>For a listing of worldwide service centers, visit our web site.</p>
For other information	<p>In North America: 1-800-TEK-WIDE (1-800-835-9433) An operator will direct your call.</p>
To write us	<p>Tektronix, Inc. P.O. Box 1000 Wilsonville, OR 97070-1000 USA</p>
Website	<p>Tektronix.com</p>

# Getting Started

This chapter describes how to install and check the TDS3TMT Telecom Mask Test application module.

## Installing Application Module and Firmware

You can install up to four application modules in the oscilloscope. Application modules go into the two slots with windows in the upper right corner of the front panel. Two additional slots are located behind the two front slots.

---

**NOTE.** *You must do the firmware install procedure the first time you install the TDS3TMT application module.*

*You do not need to reinstall the firmware if you remove and reinstall an application module.*

---



---

**CAUTION.** *To avoid damage to the oscilloscope or application module, observe the ESD precautions described on page iv.*

---

To install an application module and its associated oscilloscope firmware, do these steps:

1. Save any oscilloscope settings and/or reference waveforms to floppy disk before doing these steps.
2. Turn the oscilloscope power off.
3. Open the small door in the upper right corner of the front panel.
4. Slide the application module into any available slot with the module contacts facing the circuit board. Use a small screwdriver to remove an existing module if it is necessary to make space for a new application module.
5. Close the module door.

---

**NOTE.** If you remove an application module, the features provided by that application module are no longer available. You can reinstall the module to restore the features.

---

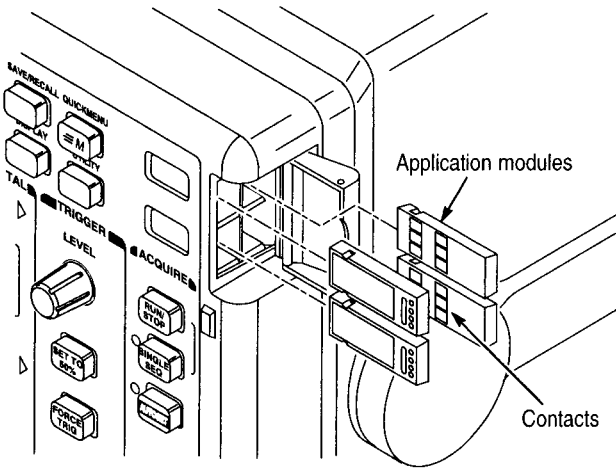



6. If the application module came with one or more floppy disks, insert the firmware upgrade floppy disk into the floppy disk drive. If there is more than one floppy disk, insert firmware upgrade floppy disk number one into the floppy disk drive.
7. Power on the oscilloscope. The oscilloscope determines whether the firmware update is necessary. If no firmware update is necessary, the oscilloscope displays the following message:

“A floppy disk has been detected which contains instrument firmware. However, the firmware on the disk is not newer than the instrument firmware.

Push **MENU OFF** to remove this message”

Push the **MENU OFF** button and then go to step 10.

If a firmware update is necessary, the oscilloscope displays the following message:

“This procedure will replace the firmware in the instrument with firmware from the floppy disk. Do not turn the instrument off or eject the floppy disk until the procedure is complete. This procedure will take approximately 7 minutes.

Push ‘OK Load New Firmware’ to proceed.”

8. Push **OK Load New Firmware** to begin loading the firmware. The oscilloscope shows a clock icon on the screen while the firmware upgrade is in process. If a second firmware floppy disk is required, the oscilloscope will instruct you to eject the first disk and insert the second disk.

When the firmware upgrade is complete, the oscilloscope will restart automatically with the new firmware.

---

**NOTE.** *If you power off the oscilloscope, eject the floppy disk, or there is a power outage during the firmware upgrade process, you must power off the oscilloscope and repeat the firmware upgrade procedure, starting at step 6, before you can use the oscilloscope.*

---

9. If you do not want to upgrade the firmware, push **MENU OFF**.

---

**NOTE.** *If you do not update the oscilloscope firmware, the new application module may not function at all, or may not function correctly. It is strongly recommended that you install new firmware.*

---

10. Do not forget to remove the floppy disk when you are done with the firmware upgrade.

You are done installing the application module and firmware.

## Checking Module Installation

Do these steps to check that the TDS3TMT Telecom Mask Test application module is correctly installed. If the oscilloscope does not show the application module menu items, do the steps in *Troubleshooting Module Installation* on page 5.

1. Power on the oscilloscope. The oscilloscope startup screen should list the newly-installed module. If the oscilloscope displays a message stating that you need to upgrade firmware, power off the oscilloscope and go to step 6 on page 3.
2. Push the **QUICKMENU** button.
3. Push the **Menu** bottom screen button to select **Telecom**. The bottom and side menus should show Telecom Mask Test commands.

## Troubleshooting Module Installation

If the oscilloscope does not recognize the application module at power-up, do these steps:

1. Turn off the oscilloscope.
2. Follow the ESD precautions listed on page iv.
3. Remove the application module (refer to step 4 on page 2).
4. Examine the oscilloscope and application module contacts for damage.
5. Reinsert the application module into the oscilloscope.
6. Turn on the oscilloscope. If the oscilloscope does not display the application menu items as listed in *Checking Module Installation*, power off the oscilloscope and reinstall the application module into a different slot.
7. Turn on the oscilloscope. If the oscilloscope now shows the application module menu items, you have a problem with one of the application module slots. Contact the nearest Tektronix service center to resolve the problem.

If the oscilloscope does not show the application menu items, power off the oscilloscope and reinstall the oscilloscope firmware by starting at step 6 on page 3 (*Installing Application Module and Firmware*).

8. If, after reinstalling the firmware, the oscilloscope still does not show the application module menu items, contact the nearest Tektronix service center.



# Operating Basics

This chapter describes the features of the TDS3TMT Telecom Mask Test application module, how to access the mask test menus, and mask test concepts.

## Telecom Mask Test Features

The TDS3TMT application module adds waveform mask testing capabilities to your TDS3000 series oscilloscope. This section provides an overview of these additional features.

### Telecom Mask Test QuickMenu

Use the telecom mask test QuickMenu function to display bottom and side menus that provide access to all key mask test functions from one screen.

### Predefined Telecom Industry Masks

The TDS3TMT application module provides compliance masks for testing to ITU-G.703 and ANSI T1.102 telecommunications standards, up to STS-1 (52 Mb/s) line rates.

### Multiple Channel Testing

The TDS3TMT application module enables you to perform multiple simultaneous testing on all active oscilloscope channels.

### **Test Automation**

You can connect the oscilloscope to do automated mask testing by using optional RS-232, GPIB, or LAN communication modules.

### **Mask Editing**

You can use WaveStar™ Software for Oscilloscopes v2.3 to edit predefined standard masks.

## **Accessing Telecom Mask Test Functions**

You can set the TDS3TMT functions from either the QuickMenu or the Utility menu. The Telecom QuickMenu provides fast access to the most frequently-used telecom mask test commands, while the Utility menus provide access to all Telecom test functions.

### **QuickMenu**

Do these steps to access and use the Telecom QuickMenu:

1. Push the **QUICKMENU** front-panel button to display the quick menu items.
2. Push the **MENU** bottom screen button to select and display the **Telecom** bottom and side menu items.

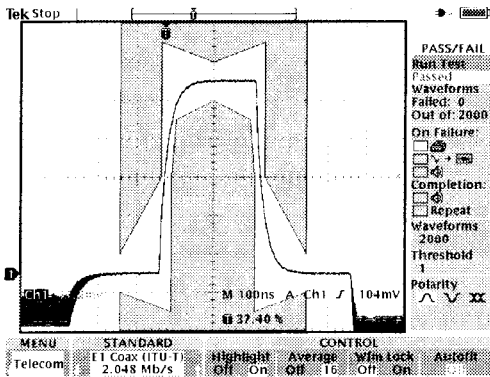

3. Push the two bottom **STANDARD** buttons to select a mask standard. The buttons let you scroll up or down through the mask list.
4. Push the **AUTOSET** front-panel button to position the waveform in the mask.
5. Push the bottom and side menu buttons to set test and pass/fail parameters.
6. Push the **Run Test** side button to run pass/fail testing.

### Utility Menu

Do these steps to access mask test functions from the Utility menu:

1. Push the **UTILITY** front-panel button to display the utility menu items.
2. Push the **System** bottom screen button to select **Apps**.
3. Push the **Module** bottom screen button to select **Telecom**. The screen displays the telecom bottom and side menu items.

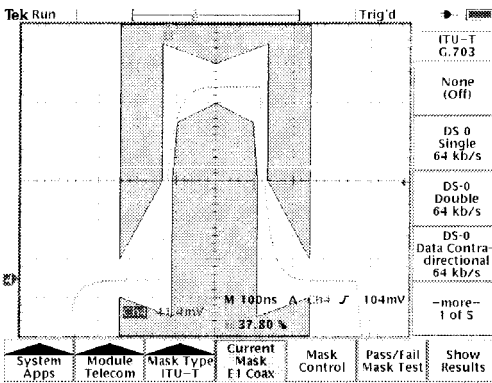

4. Push bottom and side menu buttons to select a mask, set test control parameters, and test pass/fail responses.



# Reference

The TDS3TMT application module provides waveform test masks to help you quickly analyze and evaluate telecommunications equipment signals. The following sections describe the TDS3TMT application module menus.

## Conventions

The following conventions apply to the TDS3TMT functions:

- You can perform multiple waveform mask testing by connecting signals to all oscilloscope input channels.
- While in Telecom Mask test mode, the **AUTOSET** front-panel button automatically sets the oscilloscope horizontal, vertical, and trigger parameters, and positions the waveform in the selected mask.
- Mask testing only works with live channels. It is recommended that you turn off math and reference waveforms while doing mask testing.



## TDS3TMT Menu

The following table describes the TDS3TMT application module menu items.

**Utility Menu: System = Apps, Module = Telecom**

Bottom	Side	Description
Mask Type (ITU-T)	None (Off)	ITU-T standard masks. Each mask sets the oscilloscope vertical, horizontal, and trigger controls to acquire that standard's waveform.
	DS-0 Single 64 kb/s	
	DS-0 Double 64 kb/s	
	DS-0 Data Contradirectional 64 kb/s	You can also select ITU-T standard masks in the Telecom QuickMenu.
	DS-0 Timing 64 kb/s	
	Old "DS1" Rate 1.544 Mb/s	After selecting a standard, push the <b>AUTOSET</b> front-panel button to position the waveform in the mask.
	G.703 DS1 1.544 Mb/s	
	E1 Symmetric Pair 2.048 Mb/s	The oscilloscope is set to edge trigger on waveforms (per ITU-T G.703 standard).
	E1 Coaxial Pair 2.048 Mb/s	
	Clk Interface Symmetric Pair 2.048 Mb/s	
	Clk Interface Coaxial Pair 2.048 Mb/s	
	"DS2" Rate Symmetric Pair 6.312 Mb/s	
	"DS2" Rate Coaxial Pair 6.312 Mb/s	
	E2 8.448 Mb/s	
	32.064 Mb/s	
	E3 34.368 Mb/s	
	Old "DS3" rate 44.736 Mb/s	
	G.703 DS3 44.736 Mb/s	

**Utility Menu: System = Apps, Module = Telecom**

Bottom	Side	Description
Mask Type (T1.102)	None (Off) DS1 1.544 Mb/s DS1A 2.048 Mb/s DS1C 3.152 Mb/s DS2 6.312 Mb/s DS3 44.736 Mb/s STS-1 Pulse 51.84 Mb/s	<p>ANSI T1.102 standard masks. Each mask sets the oscilloscope vertical, horizontal, and trigger controls to acquire that standard's waveform.</p> <p>You can also select T1.102 standard masks in the Telecom QuickMenu.</p> <p>After selecting a standard, push the AUTOSET front-panel button to position the waveform in the mask.</p> <p>The oscilloscope is set to isolated '1' triggering on waveforms (per ANSI T1.102 standard).</p>

**Utility Menu: System = Apps, Module = Telecom**

<b>Bottom</b>	<b>Side</b>	<b>Description</b>
Mask Type (Custom)	None (Off)	Turns off mask test mode.
	User Mask	Sets the oscilloscope to use the User mask. The User mask is saved in non-volatile memory when the oscilloscope is powered off. Use <b>Save/Recall User Mask</b> to save User masks to floppy disk.
	Copy Std Mask To User Mask	Copies the selected ITU-T or T1.102 mask into the User mask location. Use the general purpose knob to select the standard mask to copy.
	Save/Recall User Mask	Saves or recalls custom User masks. You can use WaveStar™ for Oscilloscopes Software, version 2.3, to create custom test masks for the TDS3000 Series oscilloscope.
Current Mask		Status area that displays the name of the selected mask.

## Utility Menu: System = Apps, Module = Telecom

Bottom	Side	Description
Mask Control	Highlight Violations On      Off	When <b>On</b> , turns on mask violation highlighting. Waveforms that violate mask parameters leave highlighted points on the mask that are the color of the failing waveform.
	Stop On Violation On      Off	When <b>On</b> , the oscilloscope stops mask testing on the first occurrence of a waveform violation. This function overrules pass/fail tests.
	Lock Mask To Waveform On      Off	When <b>On</b> , locks mask to waveform so that the mask segments move and redraw proportionally when changing the horizontal or vertical scale or position settings. This lets you zoom in to more closely examine waveform mask violations.

## Utility Menu: System = Apps, Module = Telecom

Bottom	Side	Description
Mask Control	Autofit Search Radius	Autofit repositions the waveform using a spiral algorithm to attempt to fit the waveform to a mask. Autofit does not change oscilloscope horizontal, vertical, or trigger settings to reposition the waveform. Refer to page 24 for more information on Autofit.
	Vertical Margin Percentage (User mask only)	<p>When enabled, adjusts the User mask vertical margins as a percent of the nominal waveform amplitude for the mask standard. This function lets you adjust the mask tolerance. Use the general purpose knob to change the Vertical Margin Percentage value.</p> <p>This function is only available for User masks. To adjust the tolerance of a standard mask, copy the standard mask into the User mask.</p>
Pass/Fail Mask test	Pass/Fail Mask Test On      Off	When <b>On</b> , resets the status information and starts pass/fail testing.

## Utility Menu: System = Apps, Module = Telecom

Bottom	Side	Description
Pass/Fail Mask test (cont.)	Status:	<p>Displays pass/fail test status information: the number of waveforms that have violated the mask per number of waveforms tested in the current test, and the number of failed tests per the total number of tests run (if Repeat on Completion is On).</p> <p>If the number of waveforms that fail exceeds the violation threshold setting, the status text changes from <b>Passing</b> to <b>Failing</b>. The test continues until the specified number of test waveforms is acquired, at which time the status changes to either <b>Passed</b> or <b>Failed</b>.</p> <p>If Stop on Violation is on, and a mask violation occurs, pass/fail testing stops and displays a status of <b>Violation</b>.</p>
	Repeat On Completion On      Off	<p>When <b>On</b>, repeats the pass/fail test cycle using the current settings. The status area Failures/Test values show how many times the test has repeated and how many of those tests failed.</p>

**Utility Menu: System = Apps, Module = Telecom**

<b>Bottom</b>	<b>Side</b>	<b>Description</b>
Pass/Fail Mask test (cont.)	Number Of Waveforms	<p>Sets the number of waveforms to acquire for each pass/fail test cycle. Use the general purpose knob to set the value. Any value above 100,000 sets the waveform count to infinity.</p> <p>If waveform averaging is on, the actual number of waveforms acquired is the Number Of Waveforms value times the waveform averaging value.</p>
	Violation Threshold For Failure	Sets how many failed waveforms define a failed test. Use the general purpose knob to set the value.
	Pre-Test Delay	Sets a time value that delays the start of a pass/fail test. Use the general purpose knob to set the value.
	Polarity	Sets the polarity of all active waveform channels. Values are positive, negative, or both. If set to Both, the oscilloscope tests the first half of all active channel acquired waveforms in normal (uninverted) mode, and then inverts all active channels and tests the second half of acquired waveforms.

**Utility Menu: System = Apps, Module = Telecom**

<b>Bottom</b>	<b>Side</b>	<b>Description</b>
Pass/Fail Mask test (cont.)	Beep On Completion On      Off	When <b>On</b> , causes the oscilloscope to emit a tone when the pass/fail test is complete.
	Beep On Failure On      Off	When <b>On</b> , causes the oscilloscope to emit a tone when the pass/fail test status changes from <b>Passing</b> to <b>Failing</b> .
	Hard Copy On Failure On      Off	When <b>On</b> , causes the oscilloscope to send the screen image to the hard copy device when the pass/fail test status changes from <b>Passing</b> to <b>Failing</b> .
	Save Failed Wfm To Disk On      Off	When <b>On</b> , causes the oscilloscope to save the failing signal waveform(s) data to the oscilloscope disk drive when the mask test the pass/fail test status changes from <b>Passing</b> to <b>Failing</b> . Refer to page 21 for more information on saving waveforms to disk.



## Utility Menu: System = Apps, Module = Telecom

Bottom	Side	Description
Show Results	Count Hits On      Off	When <b>On</b> , displays the number of mask hits (failures) per channel and per mask segment. Enabling count hits slows down the mask test rate; if mask test speed is important, turn Count Hits Off.  When set to On, the display also shows the mask segment number next to each mask segment.
	Violations/Waveforms, ...	Displays pass/fail test status information: the number of waveforms that have violated the mask per number of waveforms tested in the current test, and the number of failed tests per the total number of tests run (if Repeat is On).  If the number of waveforms that fail exceeds the violation threshold setting, the status text changes from <b>Passing</b> to <b>Failing</b> . The test continues until the specified number of test waveforms is met.
	Segment 1 Hits ... Segment 8 Hits	Status area that displays the number of hits for each channel on each mask segment.

### Key Points

**Automated Pass/Fail Testing Process.** The recommended automated pass/fail testing process is:

1. Set the oscilloscope to default settings using the **SAVE/RECALL->Recall Factory Setup** menu.
2. Set the Graticule type to Frame (**DISPLAY->Graticule** menu).
3. Select the mask standard.
4. Turn off all waveforms not being tested.
5. Connect the appropriate input signals.
6. Push the **Autoset** button.
7. Set Autofit to a reasonably small value, such as 4.
8. Set Polarity to **Both**.
9. Set the number of Waveforms to 100.
10. Run the pass/fail test.
11. Note the pass/fail test status (Passed or Failed) and take appropriate action.
12. Connect new signals.
13. Repeat from step 10.

**Mask Testing and Pass/Fail Testing.** Mask testing means the detection and highlighting of mask segment violations. Pass/Fail testing is setting conditions for mask testing, such as the number of waveforms to test, how many mask violations are allowed before failing a test, whether to repeat testing upon completion, what action to perform at the completion of a test, and so on.

**Turn Off Mask Testing.** To turn off mask testing and remove the mask from the screen, set the mask standard to **None**.

**Standards and Pulse Amplitudes.** For those cases where a mask standard defines a valid pulse amplitude as being within a range of values, the TDS3TMT mask is drawn for the maximum permitted amplitude.

For those cases where a mask standard does not define pulse amplitude, the TDS3TMT mask is drawn for a nominal 1 V pulse.

**Highlight Violations.** Highlight Violations must be on in order for the oscilloscope to perform mask comparisons. If Highlight Violations is off, the oscilloscope will not inform you of mask violations using highlighting or the Stop On Violation command, and hits counting will not count. Also, turning on pass/fail testing, Count Hits, or Stop on Violation automatically turns on Highlight Violations.

**Saving Waveforms to Disk.** The default saved file name is TEKnnnnn.fff, where nnnnn is an incrementing number that usually starts at 00000, and fff is the file format (Internal, Spreadsheet, or Mathcad file format) as set in the **SAVE/RECALL > Save Waveform to File** menu. For internal file format waveforms (.isf), if more than one waveform is being tested, look at the .isf file preamble information at the top of the file to determine from which channel that waveform data came. Refer to the *TDS3000 Series Programmer Manual* for .isf file format information.

**Proper Signal Termination.** Make sure to correctly terminate communication test signals. Tektronix offers optional AMT75 and AFTDS adapters for correct communication signal termination.

**Pass/Fail Testing: Polarity.** When polarity is set to both, the oscilloscope tests the first half of all active channel acquired waveforms with positive polarity, and then inverts all active channels and tests the second half of acquired waveforms.

**Pass/Fail Testing: Averaging.** When averaging is on, the oscilloscope first generates an averaged waveform, then the averaged waveform is compared to the mask. This means that the total number of waveforms acquired is equal to the waveform averaging number times the number of waveforms being tested. For example, if pass/fail Number of Waveforms is set to 500, and waveform averaging is set to 8, then the total number of waveforms acquired for one pass/fail test cycle is  $500 \times 8 = 4,000$ .

**Triggering.** Selecting a mask standard automatically sets trigger parameters for that standard. However, to assign specific trigger parameters to a mask (most likely for a new User mask), push the Trigger **MENU** button, select **Comm**, and select the mask standard to use for triggering. The oscilloscope assigns the selected standard's trigger parameters to the current mask.

**Testing For Infrequent Errors.** To automatically capture and save waveform violations that occur infrequently over long periods of time, set Pass/Fail testing Repeat to **On**, Number of Waveforms to **1**, and Hardcopy/Wfm On Failure to **On**. You may also want to set **UTILITY > Hard Copy > Options > Compression** to **ON** to compress the saved hardcopy data and thus store more files on the floppy disk. Compression is not available for waveform (\*.isf) format data.

**On-Screen Mask Positions.** Many of the mask standards have their mask drawn on the right side of the graticule to allow enough room to the left for acquiring sufficient serial trigger data.

When using the Lock Mask To Waveform feature, be careful not to move the mask too far left or else you may lose your serial trigger. Use Lock Mask To Waveform after acquisitions have stopped to examine a mask violation more closely.

To use Lock Mask to Waveform to make the mask fill more of the screen, increase the acquisition record length by pushing **ACQUIRE > Horizontal Resolution > Normal** to set the record length to 10K points (note that Normal mode only works with lock mode for horizontal settings of 100 ns/div or faster). You can also use Zoom to examine a mask and waveform, provided that you pan and zoom in such a way that there is enough space to the left of the mask for the oscilloscope to detect the serial trigger.

**Stop On Violation.** If Stop On Violation is On, the pass/fail status area displays **Violation** if there is a violation, regardless of the pass/fail test settings. In other words, Stop On Violation has a higher precedence than pass/fail tests.

**Running Mask Test Indefinitely.** To run a pass/fail test indefinitely while counting the number of violations, set **Number of Waveforms** to infinity ( $\infty$ ).

**Pass/Fail Status Count.** If pass/fail testing stops prior to completion (either by pushing the **Run Test** or **Pass/Fail Mask Test** side menu button, or the number of violations exceed the Violation Threshold setting), the number of failures or violations displayed is one less than the actual number of waveforms tested.

**Autofit Key Points.** The following are some Autofit-specific key points:

- The Autofit radius defines the size of a square search grid radius of  $(2 \times \text{radius} + 1) \times (2 \times \text{radius} + 1)$  pixels, centered on the waveform position. Autofit moves the waveform using a spiral pattern, testing for mask violations at each position. For example, the following table represents a spiral pattern for a radius value of 2, where the number represents the order of the waveform moves, and the position of the number represents the position the waveform is offset relative to the starting point (s). A radius of two attempts to fit the waveform in 25 tries (start position plus 24).

9	10	11	12	13
24	1	2	3	14
23	8	s	4	15
22	7	6	5	16
21	20	19	18	17

- If the waveform is a significant distance from the mask, AUTOSET should be used first to adjust the vertical, horizontal, and trigger parameters.
- When numerous waveforms are violating the mask by substantial amounts, thereby causing Autofit to run almost continuously, the instrument responsiveness is significantly degraded. This is another reason why AUTOSET is more appropriate than Autofit for waveforms which violate the mask by large amounts.

- When Autofit runs due to a waveform violation, and if Autofit fails to find a location where the waveform fits the mask without any violations, Autofit remembers the position that resulted in the least number of mask violations. Then on subsequent acquisitions which violate the mask, Autofit changes its starting point (s) to the point where it previously found the fewest violation points. This can result in the waveform appearing to migrate around the screen by amounts which exceed the specified search radius. This is normal behavior.
- When Autofit moves the waveform, it only moves the location where the waveform is drawn on the display. It does not change any of the underlying vertical, horizontal, or trigger parameters used to acquire the waveform.

A consequence of this is that when moving the waveform left (or right), the waveform points at the right (or left) edge of the screen will be blank if the horizontal settings are such that the entire acquired waveform is displayed on screen. This is okay because those points are typically outside the mask region.

- If pass/fail testing is used in conjunction with Autofit, the Autofit center point is reset at the beginning of each pass/fail test.
- Autofit is most appropriate when the waveform(s) being tested is already close to fitting inside the mask.

## Telecom Pass/Fail Mask Test Example

In this example, you want to test an ITU-T telecom signal that needs to meet the E1 Coaxial Pair 2.048 Mb/s standard. You want to highlight any waveform mask errors, as well as set up pass/fail testing to test 500 waveforms, then stop.

Use the Telecom QuickMenu to set the TDS3TMT mask parameters as listed in the table. Connect the signal to CH 1 on the oscilloscope, then press the **AUTOSET** front-panel button. After Autoset completes, press the **Run Test** side menu button to perform the pass/fail test.

### Telecom QuickMenu

Menu Item	Parameter	Value
Standard	Use buttons to scroll through mask standard list	E1 Coax (ITU-T) 2.048 Mb/s
Control	Highlight	On
	Average	Off
	Wfm Lock	Off
	Autofit	On ( $\geq 1$ )
Pass/Fail	Send hardcopy to printer	Off (unchecked)
	Send waveform to file	Off (unchecked)
	Beep on failure	On (checked)
	Beep on completion	On (checked)
	Repeat test	Off (unchecked)
	Waveforms	500
	Threshold	1
Polarity	Positive	



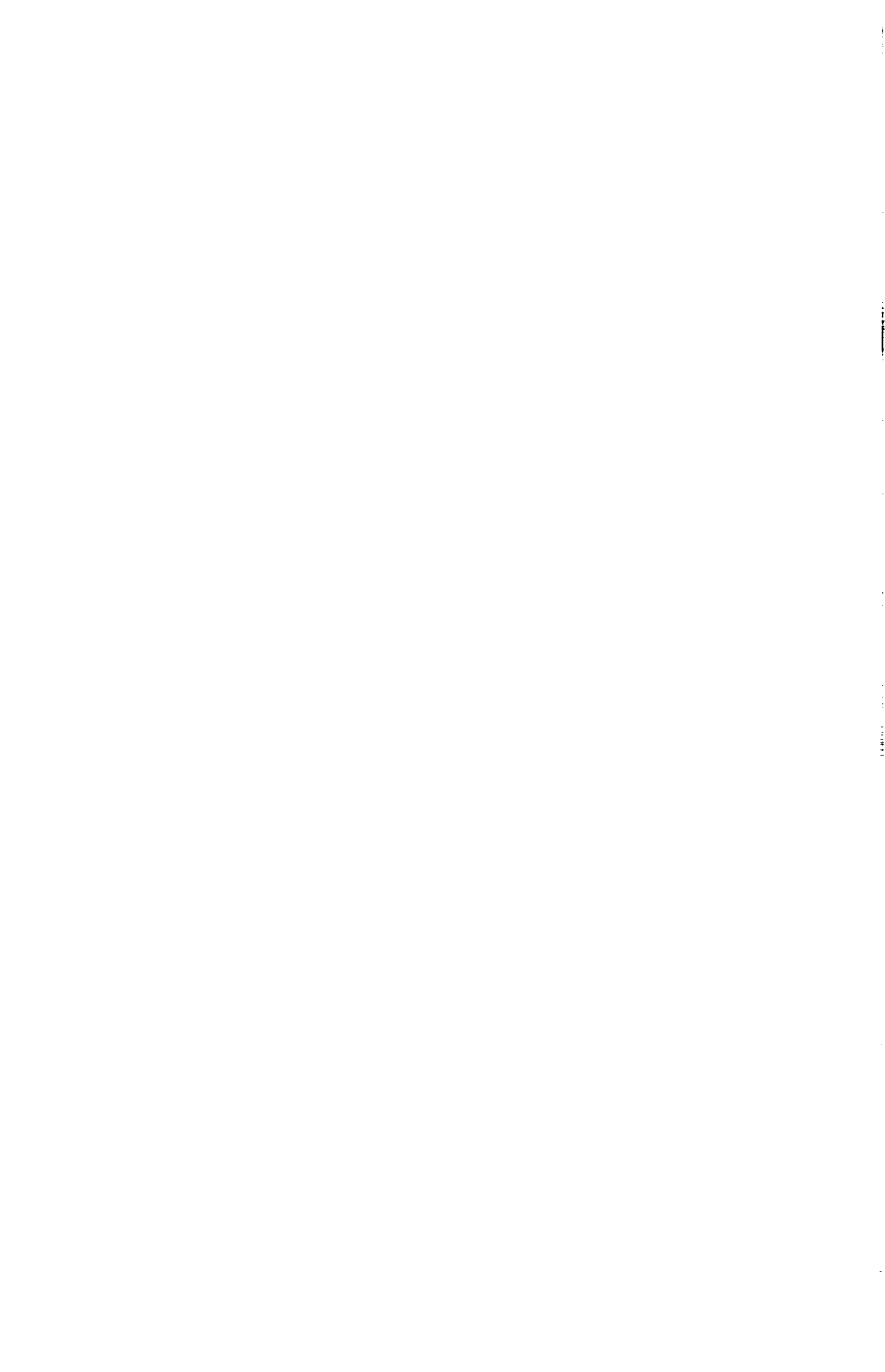



Printed on recyclable paper. Please recycle.